



**NARDI**  
YOUR OUTDOOR LIVING

**OUTDOOR**  
2022

**outdoor**  
design Raffaello Galiotto

## O come Outdoor

Vivere all'aria aperta, con lo sguardo rivolto verso il mare, immersi nel verde o in un'oasi in città. Suggestioni di design e idee per abitare gli spazi esterni, scegliendo tra un vasto numero di collezioni, misure e colori.

I nostri arredi celebrano il desiderio di relax all'aperto, definiscono gli ambienti contemporanei con stile e personalità incontrando le esigenze di componibilità e versatilità.

Li realizziamo completamente in Italia con materiali di qualità adatti a restare all'esterno, sono riciclabili e pensati per un utilizzo intensivo e un lungo ciclo di vita.

## O for Outdoor

*Living in the open air, with a view of the sea, surrounded by greenery or in a green oasis in the city. Stylish design solutions and ideas for outdoor living, allowing you to choose from a large number of collections, dimensions and colours.*

*Our furniture enhances the desire to relax outdoors, adding style and personality to contemporary environments while meeting the need for modularity and versatility.*

*We make our furniture entirely in Italy using high-quality materials suited to remaining outdoors. It is recyclable and designed for intensive use and a long life cycle.*

# index

|     |  |
|-----|--|
| 8   | <i>komodo modular system</i>             |
| 36  | dogo                                     |
| 44  | <i>folio my special place</i>            |
| 60  | rio / dogo • trill • net                 |
| 78  | set rio bench Alu                        |
| 84  | alloro • palma                           |
| 94  | net collection                           |
| 104 | aria                                     |
| 110 | loto • ninfea                            |
| 118 | atlantico • pop                          |
| 127 | <i>schede tecniche/technical details</i> |

# Komodo *modular system*

Sistema di sedute imbottite modulare componibile a piacere per creare il proprio living a cielo aperto.

Ispirata all'intreccio dei rami degli alberi, la struttura dona grande personalità all'arredo, accoglie i cuscini in diversi colori e tessuti e si completa con la nuova copertura Ombra per vivere il piacere dell'aria aperta e della socialità protetti dal sole.

*A modular upholstered seating system that can be arranged as required to create your open-air living space.*

*Inspired by the lattice pattern of tree branches, its frame adds great character to furnishings, accommodating cushions in various colours and fabrics. Komodo is complemented by the new Ombra covering so you can enjoy the pleasure of being in the open air and socialising, protected from the sun.*



GOOD DESIGN  
AWARD 2019  
winner





KOMODO bianco / giungla  
KOMODO OMBRA 2 bianco / velo white  
KOMODO TAVOLINO bianco



KOMODO bianco / ghiaccio  
KOMODO OMBRA 2 bianco / velo white  
KOMODO TAVOLINO bianco





KOMODO antracite / canvas  
KOMODO OMBRA 3 antracite / velo white  
KOMODO TAVOLINO antracite

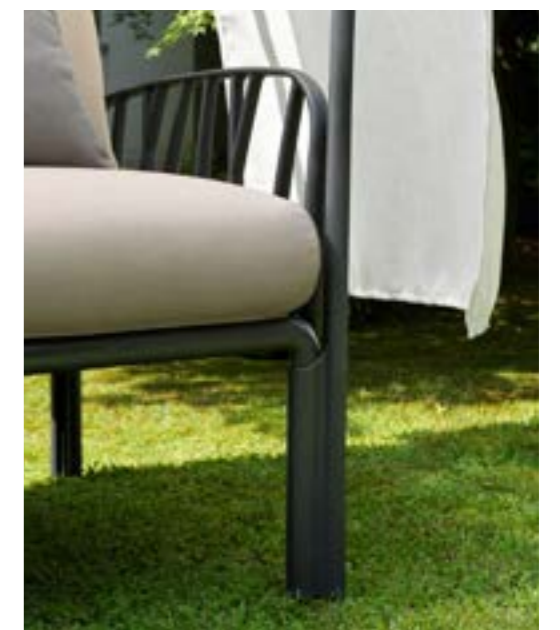
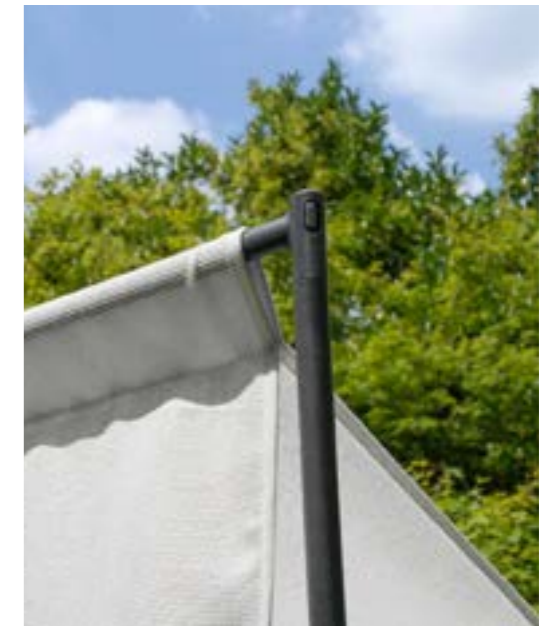





KOMODO agave / avocado - giungla  
KOMODO TAVOLINO agave



KOMODO POLTRONA agave / giungla



KOMODO POLTRONA agave / avocado



KOMODO agave / avocado - giungla  
KOMODO TAVOLINO agave





KOMODO bianco / canvas  
KOMODO TAVOLINO VETRO bianco / vetro



KOMODO bianco / canvas  
KOMODO TAVOLINO VETRO bianco / vetro

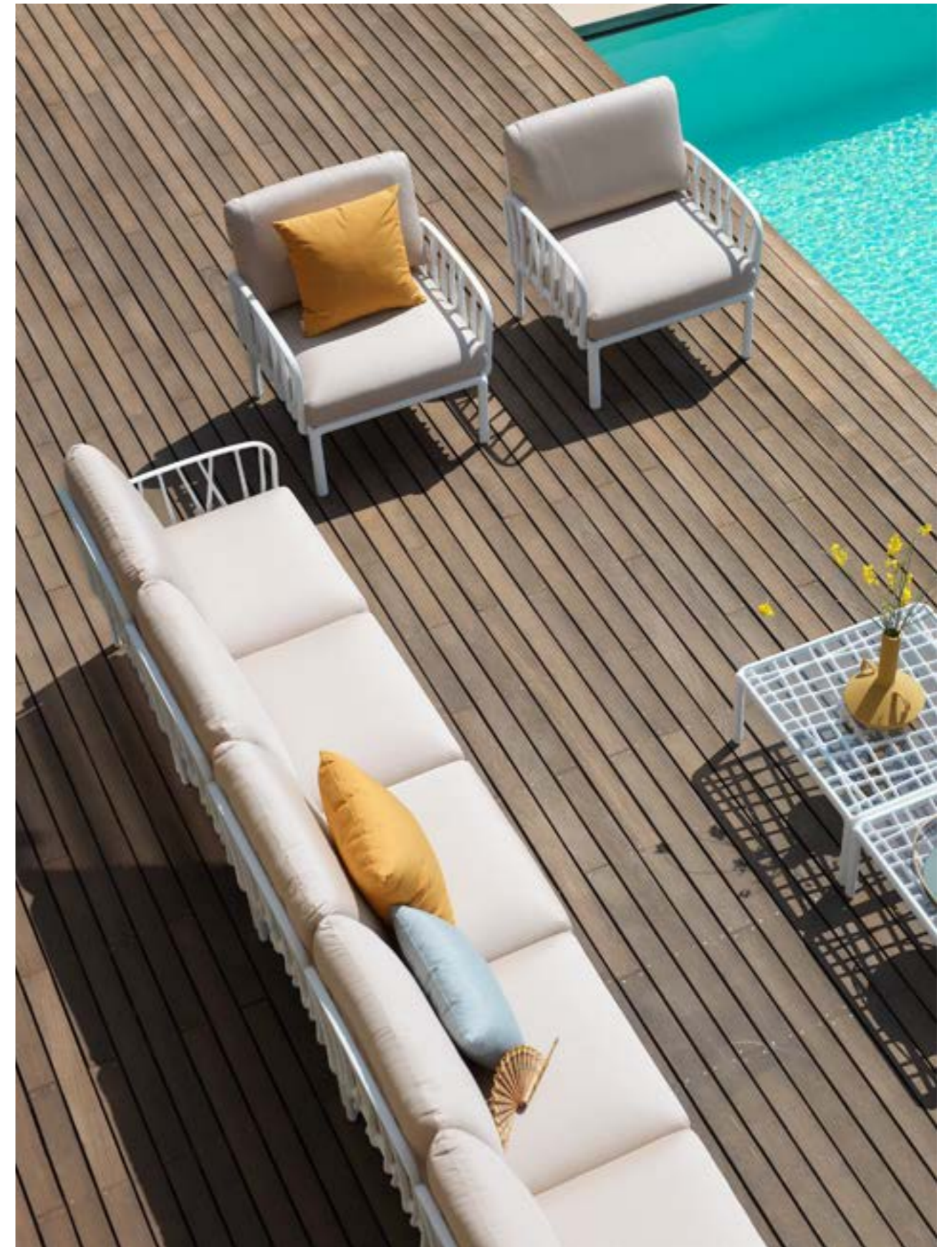



KOMODO TAVOLINO VETRO antracite / vetro



KOMODO antracite / rosa quarzo



KOMODO POLTRONA bianco / grigio komodo  
KOMODO TAVOLINO VETRO bianco / vetro



KOMODO TAVOLINO VETRO bianco / vetro



KOMODO 5 tortora / ghiaccio  
KOMODO TAVOLINO tortora





FOLIO ROCKING tortora / lino  
SIPARIO 3 terra

KOMODO 5 tortora / giungla  
KOMODO POUF tortora / giungla  
KOMODO TAVOLINO tortora



KOMODO 5 tortora / giungla  
KOMODO POUF tortora / giungla  
KOMODO TAVOLINO tortora  
SIPARIO 3 terra



# Doga

Inediti cromatismi, estetica e funzionalità, forme invitanti per godere della vita all'aria aperta.

Tutta la leggerezza di Doga, sedute con e senza braccioli e versione lounge, per una collezione fresca, dinamica e versatile ispirata al tema della doga reinterpretata in chiave contemporanea.

*New colours, aesthetic design and functionality, with attractive shapes for enjoying life in the open air.*

*All the lightness of Doga chairs with and without armrests, and a lounge version for an original, dynamic and versatile collection inspired by a slatted design given a contemporary twist.*





DOGA RELAX cappuccino - agave  
DOGA TABLE agave



DOGA BISTROT agave / lino  
 DOGA ARMCHAIR agave / lino  
 DOGA RELAX agave / lino

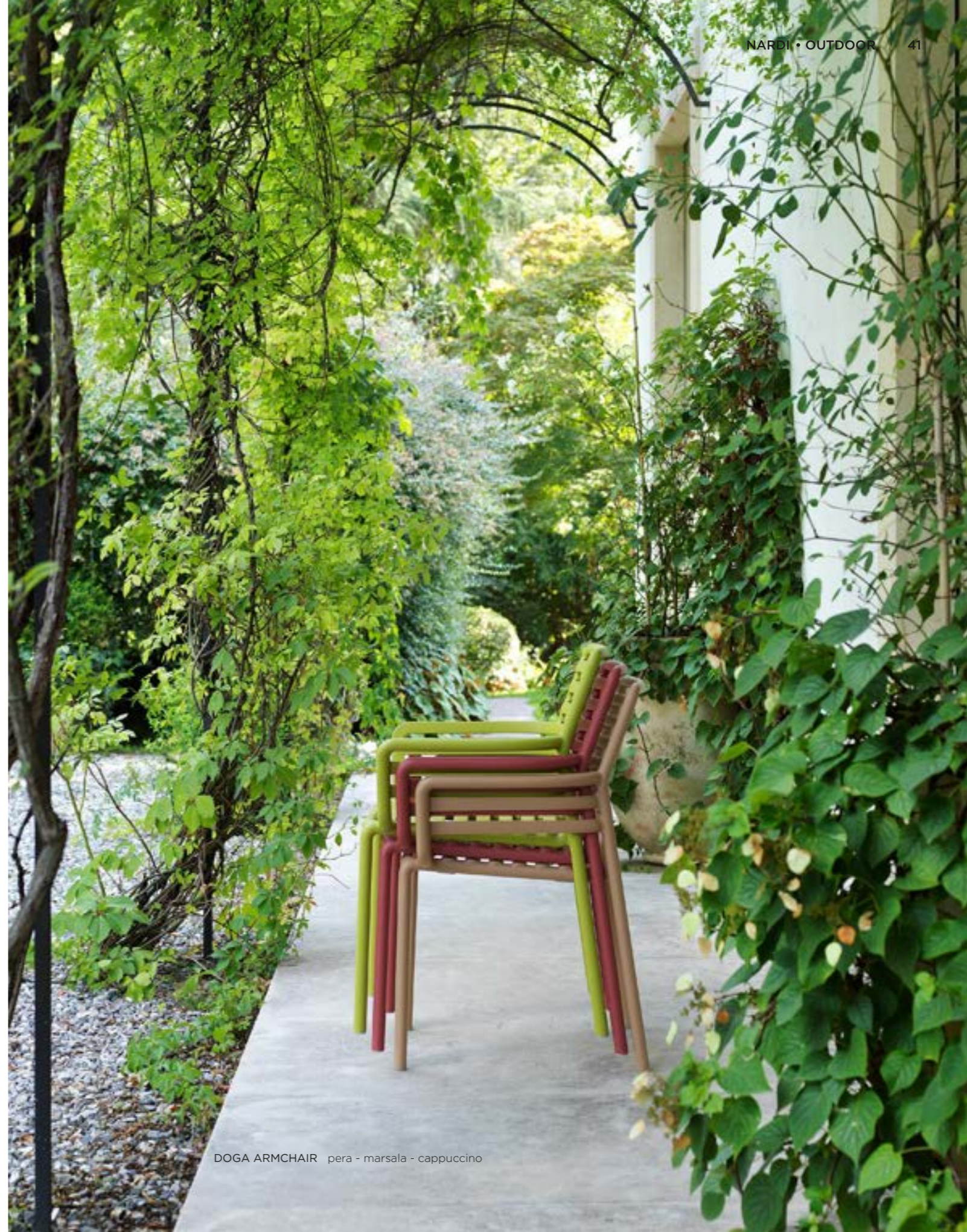

DOGA ARMCHAIR pera - marsala - cappuccino



DOGA RELAX pera  
DOGA TABLE agave



# Folio *my special place*

Il morbido e piacevole abbraccio di una poltrona davvero speciale.  
Folio è un'innovativa poltrona relax proposta a base fissa o nella romantica versione a dondolo, reclinabile in due posizioni e completata dal poggiatesta/sgabello Poggio.  
Uno stile curato nei dettagli, delineato dall'unione di linee pure, colori e imbottiti per incantevoli angoli di relax.

*The soft and pleasant embrace of a very special armchair.*

*Folio is an innovative relaxing armchair available with a fixed base or in a romantic rocking version. It reclines to two positions and can be complemented with the Poggio footrest/stool.*

*Its style features meticulous details, highlighted by a combination of elegant lines, colours and padded elements that allow charming corners of relaxation to be created.*



GOOD DESIGN  
AWARD 2020  
winner



archiproducts  
DESIGN AWARDS  
WINNER 2020



reddot winner 2021









FOLIO tabacco  
POGGIO tabacco



FOLIO tabacco / felce  
POGGIO tabacco



FOLIO antracite



FOLIO antracite / rosa quarzo  
POGGIO antracite  
SPRITZ antracite



FOLIO agave / artic





POGGIO agave



FOLIO bianco / lino  
FOLIO ROCKING bianco / lino  
POGGIO bianco



FOLIO agave / lino  
POGGIO agave

## Rio / Doga • Trill • Net

Chiacchierare, ridere, raccontare, trovare sempre un posto per chi arriva all'improvviso. Tavoli allungabili dalla movimentazione facile e invisibile, sedute di diverse forme, colori e gradi di comfort che permettono di creare scenografie outdoor su misura.

*Chatting, laughing and telling stories, always finding a place for those who turn up unexpectedly.*

*Tables that extend with a simple concealed movement and chairs in various shapes, colours and levels of comfort that allow you to create customised outdoor settings.*





RIO ALU 210 EXTENSIBILE antracite  
DOGA ARMCHAIR bianco - antracite  
DOGA BISTROT bianco - antracite





RIO ALU 210 EXTENSIBLE antracite  
 DOGA ARMCHAIR antracite  
 DOGA BISTROT bianco



RIO ALU 210 EXTENSIBLE antracite  
 DOGA ARMCHAIR bianco



RIO ALU 210 EXTENSIBLE antracite  
TRILL ARMCHAIR agave



RIO ALU 210 EXTENSIBLE antracite  
TRILL ARMCHAIR agave



RIO ALU 210 EXTENSIBLE antracite



RIO ALU 210 EXTENSIBLE antracite  
NET senape



RIO ALU 210 EXTENSIBLE antracite  
NET senape





RIO 210 EXTENSIBLE tortora  
NET RELAX tortora / rosa quarzo



RIO 140 EXTENSIBLE bianco  
BIT bianco



BIT salice

## Set Rio Bench ALU

Nuove e informali idee per godere della convivialità a cielo aperto. La panca Rio Bench riprende le caratteristiche doghe del tavolo allungabile Rio e definisce gli ambienti outdoor in totale libertà accendendo la spensieratezza e la voglia di stare insieme.

*New, informal ideas for enjoying convivial moments outdoors. Rio Bench echoes the characteristic slats of the extensible Rio table, freely creating outdoor environments while fostering light-heartedness and the desire to be together.*







SET RIO BENCH ALU tortora



RIO BENCH ALU tortora



SET RIO BENCH ALU tortora

## Alloro • Palma

Versatilità e facilità d'utilizzo sono le connotazioni dei tavoli allungabili Nardi che vantano alte prestazioni e disegnano conviviali scenari nel nome di tecnica e design. Le armoniose silhouette della struttura dei tavoli e delle sedute abbinata evocano quelle dei classici listelli di legno.

*Nardi's extending tables are versatile and easy to use, offering high performance while creating convivial arrangements focused on technology and design. The harmonious silhouettes of the table frames and matching chairs are reminiscent of classic wooden slats.*





ALLORO 210 EXTENSIBLE tortora / tortora  
PALMA tortora / tortora



ALLORO 210 EXTENSIBLE tortora / tortora  
PALMA tortora / tortora



ALLORO 210 EXTENSIBLE tortora / tortora



ALLORO 140 EXTENSIBLE bianco / tortora  
PALMA bianco / tortora



ALLORO 140 EXTENSIBLE bianco / tortora



PALMA bianco / tortora

# Net collection

Raffinato relax, interpretato da armoniche palette di colori che si compongono e contrappongono in un gioco di elementi - poltroncine, divanetti, tavolini e cuscini - che dialogano tra loro per personali look open air.

*Refined relaxation is expressed with harmonious colour palettes that are combined and contrasted in an interplay of elements - armchairs, sofas, side tables and cushions - that come together for a personal open-air look.*

NET RELAX awards



GOOD DESIGN  
AWARD 2018  
winner



reddot award 2018  
winner



selected by  
ADI DESIGN  
INDEX 2017







NET BENCH salice / sardinia  
NET RELAX salice / sardinia  
NET TABLE 100 salice



NET RELAX salice / sardinia



NET TABLE 100 salice



NET BENCH bianco / grigio  
NET RELAX bianco / grigio  
NET TABLE 100 bianco



NET BENCH senape / denim  
CUSCINO PASSEPARTOUT denim



NET BENCH senape / denim  
NET RELAX senape / denim  
NET TABLE 100 senape

## Aria

Progettare salotti all'aperto per godere delle serate in compagnia, della brezza del mare, dell'aria fresca di montagna. Le doghe, fil rouge stilistico della collezione, disegnano poltroncine e tavolini personalizzabili con una vasta scelta di cuscini di diverse forme e colori.

*Creating outdoor lounges for enjoying evenings in company, with a sea breeze or fresh mountain air.*

*Slats, the recurring stylistic theme of the collection, give shape to armchairs and side tables that can be customised with a wide choice of cushions in various shapes and colours.*





ARIA POLTRONA bianco / sardinia  
ARIA TAVOLINO 100 bianco



ARIA POLTRONA tortora / lime  
ARIA TAVOLINO 100 tortora

## Loto • Ninfea

Atmosfere contemporanee, create attraverso l'incontro di diversi materiali - vetro, metallo, resina - che sottolineano la qualità e la ricercatezza di una collezione che assolve alle tante esigenze del vivere gli spazi all'aperto.

*Contemporary atmospheres, created by combining different materials - glass, metal, resin - that underline the quality and refinement of a collection that meets the many requirements of outdoor living.*





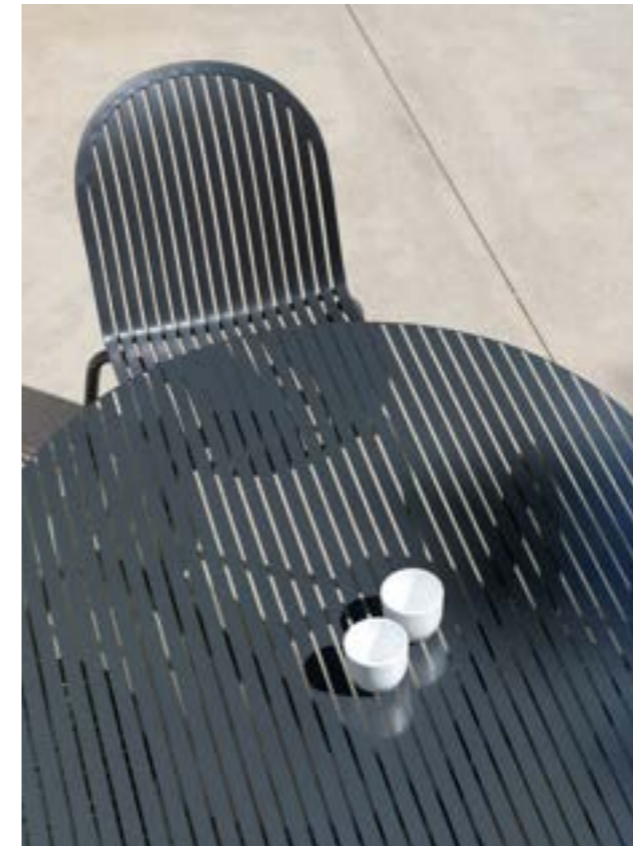

LOTO DINNER 190 antracite / antracite  
NINFEA DINNER antracite / antracite



LOTTO RELAX 95 bianco / bianco  
NINFEA RELAX bianco / bianco



NINFEA RELAX bianco / bianco



LOTO RELAX 95 bianco / bianco

## Atlantico • Pop

Rituali di benessere sia per gli occhi che per il corpo.  
Atlantico e Pop uniscono la massima ergonomia alla qualità di dettagli e materiali.  
Un concept estetico dalle linee pure ed essenziali in un'ampia scelta di colori.

*Rituals of wellbeing for the eyes and the body.*

*Atlantico and Pop combine excellent ergonomics with quality details and materials.  
An aesthetic concept with simple elegant lines and a wide choice of colours.*

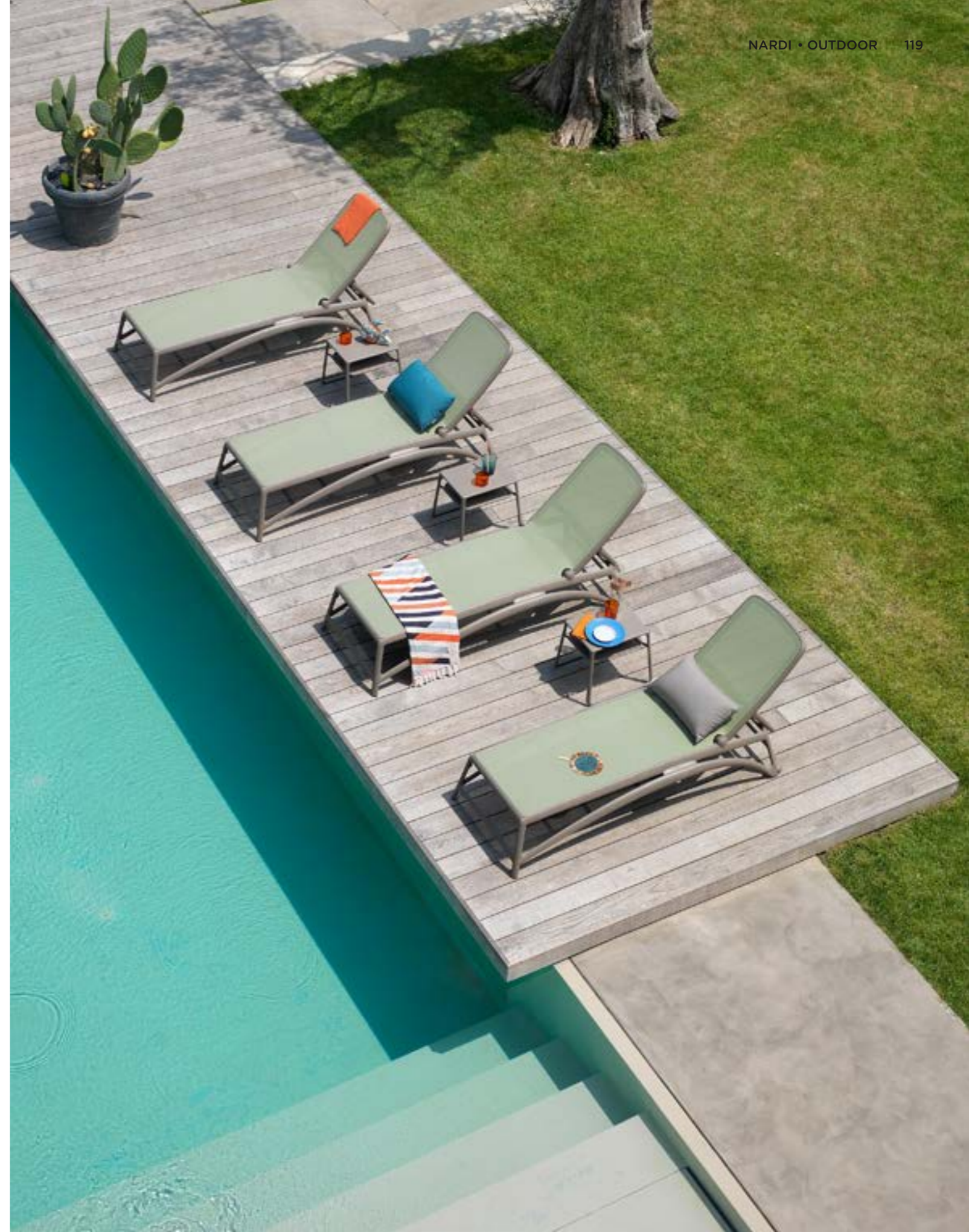



ATLANTICO tortora / agave



POP tortora



ATLANTICO bianco / bianco  
POP bianco



ATLANTICO antracite / antracite  
POP antracite

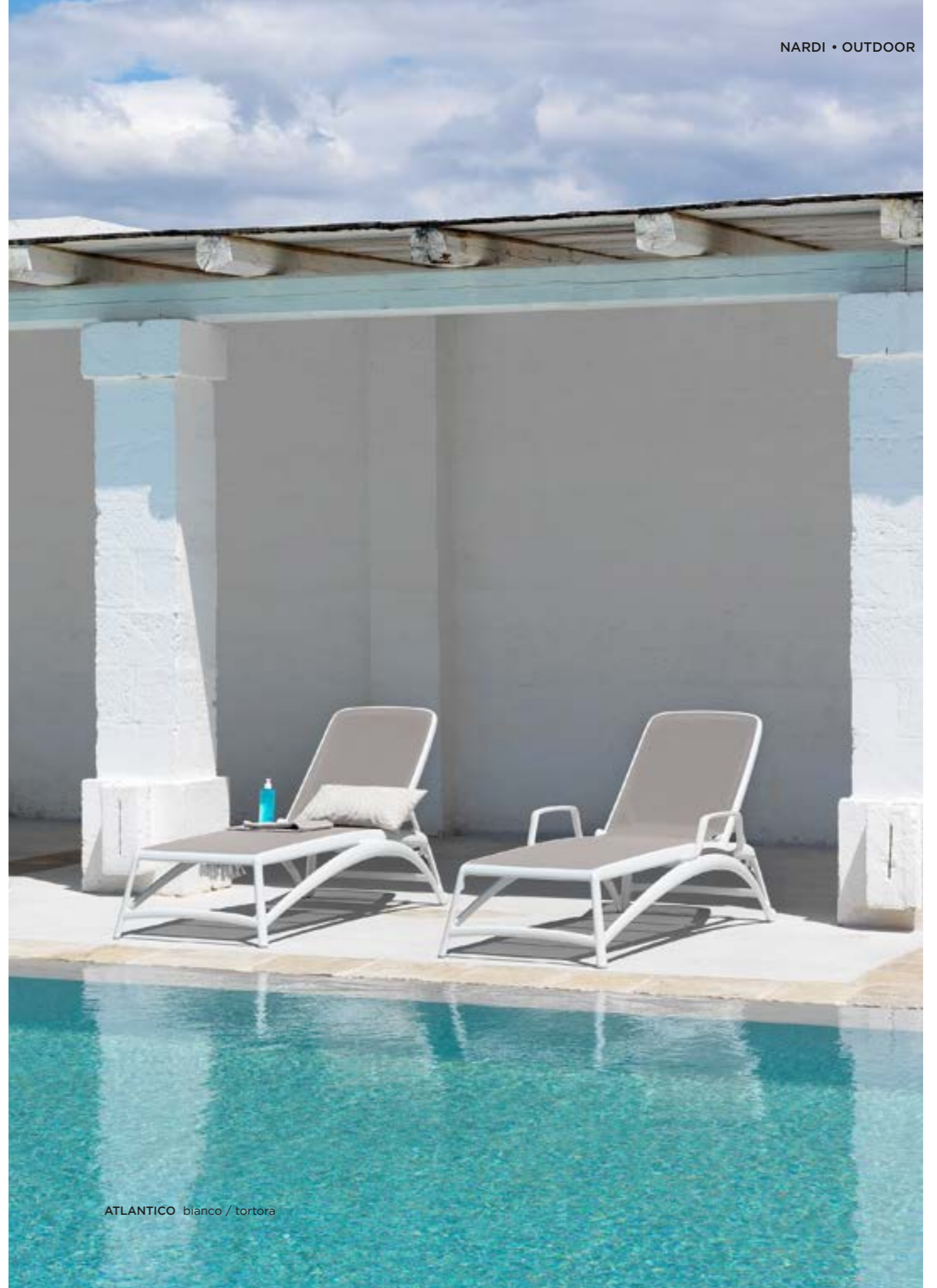

ATLANTICO bianco / tortora

schede tecniche  
*technical details*



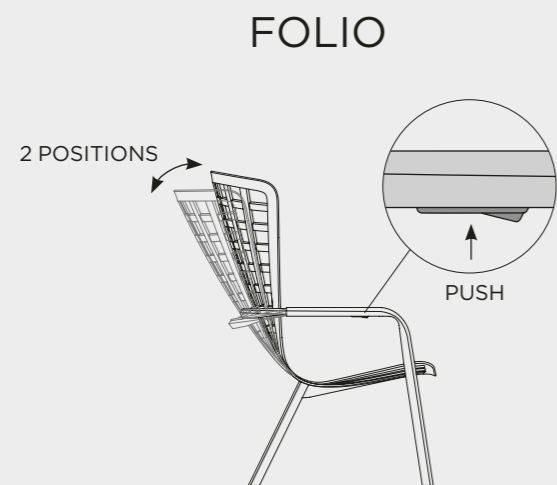

## FOLIO ROCKING

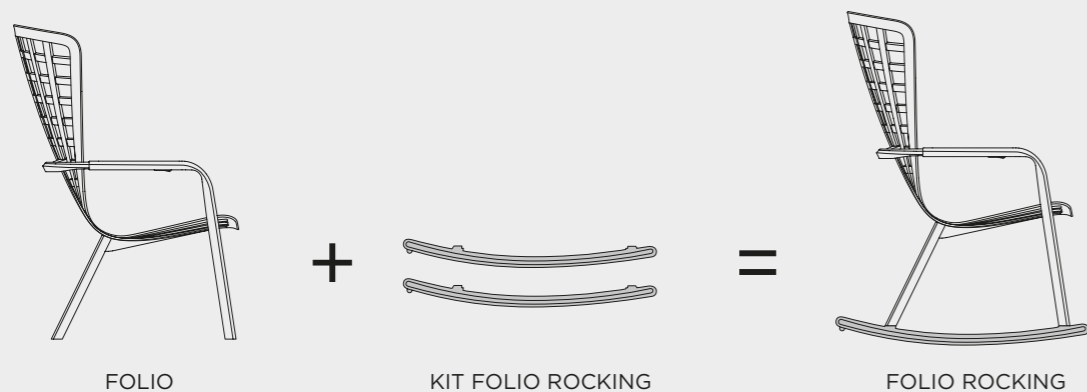

FOLIO è una innovativa poltrona relax a due posizioni pensata per l'outdoor, proposta su base fissa, con poggiatesta, oppure nella romantica versione a dondolo. L'ampia scocca della poltrona è costituita da un unico foglio dal design sapientemente curvato in modo da permettere il movimento tra seduta e schienale sfruttando l'elasticità del materiale senza l'ausilio di elementi di congiunzione o di rotazione.

*FOLIO is an innovative relaxing armchair, adjusting to two positions, designed for outdoor use. It is available with a fixed base and a footrest, or in a romantic rocking version. The large structure of the armchair is made from a single perforated sheet. It has an expertly curved design that allows movement between the seat and back, exploiting the flexibility of the material without requiring any linking or rotating elements.*

## FOLIO

polipropilene fiberglass

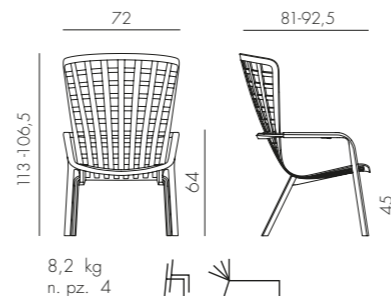

BIANCO 40300.00.000.04 ANTRACITE 40300.02.000.04 TORTORA 40300.10.000.04 AGAVE 40300.16.000.04 TABACCO 40300.53.000.04

## KIT FOLIO ROCKING

polipropilene fiberglass

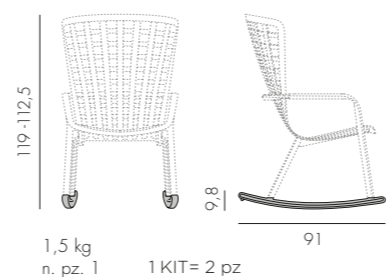

BIANCO 40298.00.000 ANTRACITE 40298.02.000 TORTORA 40298.10.000 AGAVE 40298.16.000 TABACCO 40298.53.000

## POGGIO

polipropilene fiberglass

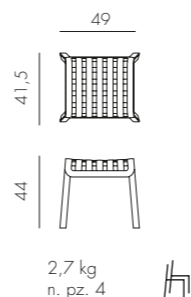

BIANCO 40044.00.000 ANTRACITE 40044.02.000 TORTORA 40044.10.000 AGAVE 40044.16.000 TABACCO 40044.53.000

## CUSCINO FOLIO COMFORT

tessuto

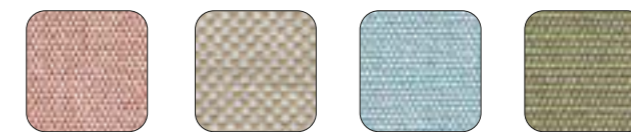
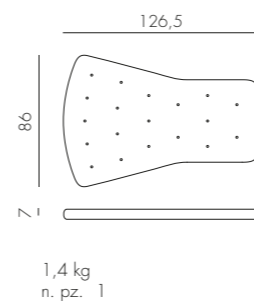

rosa quarzo # 36300.01.066 lino 36300.01.152 artic # 36300.01.161 felce # 36300.01.162

# Variazioni di colore sono da ritenersi standard e naturali nei tessuti acrilici tinto filo. Posizionare in zone d'ombra - Colour variations are to be considered standard and natural in yarn-dyed acrylic fabrics. Position in shaded areas - Les variations de couleur des tissus acryliques au fil teint sont standard et naturelles. Placer dans des zones ombragées - Farbveränderungen sind als Standard und in im Garn gefärbten Acrylgeweben als natürlich zu betrachten. In schattigen Bereichen aufstellen - Las variaciones de color son normales y naturales en las telas acrílicas teñidas en hilo. Colocar en zonas de sombra - As variações de cor são consideradas standard e naturais nos tecidos acrílico tingidos com fio. Posicionar em zonas de sombra - Boyalı akrilik iplik kumaşlarda renk değişiklikleri standart ve doğal kabul edilir. Gölge alanlara yerleştiriniz - Изменения цвета следует считать нормой, они являются естественными в случае акриловых тканей с окрашенными волокнами. Размещать в тени

## KOMODO

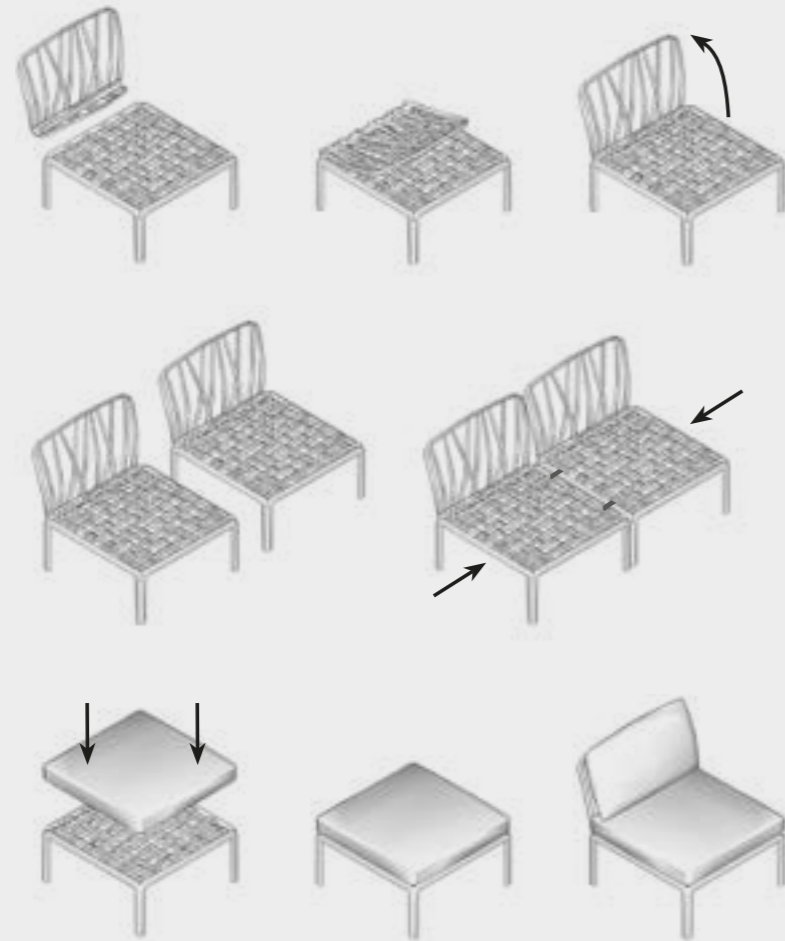

KOMODO è un sistema modulare di sedute configurabile a piacere. I moduli possono essere fissati tra loro e gli schienali e i braccioli sono agganciabili su tutti i lati della seduta. Oltre alla versione standard KOMODO 5, è possibile configurare e ordinare la tua versione personalizzata elencando tutti i singoli elementi che la formano.

*KOMODO is a modular system of upholstered seats which can be configured to suit your particular needs. The modules can be secured to one another and the backrests and armrests can be attached on all sides of the seat.*

*In addition to the standard KOMODO 5 version, you can configure and order your own customized version simply by listing all the individual elements you require.*

## KOMODO POLTRONA

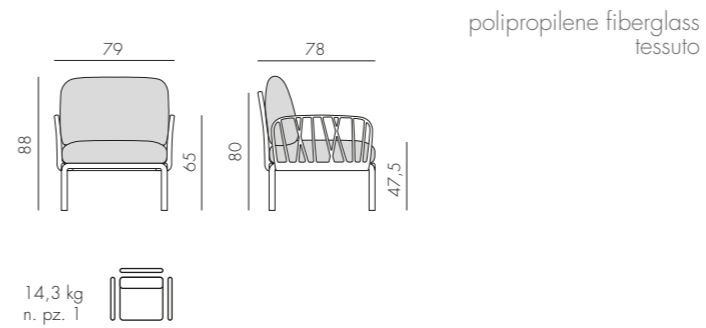

## KOMODO ELEMENTO TERMINALE DX/SX

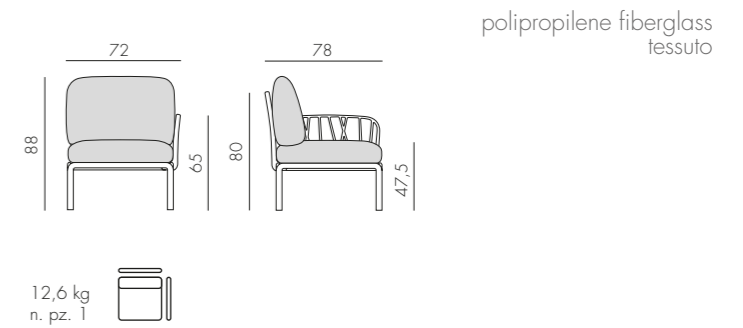

## KOMODO ELEMENTO CENTRALE

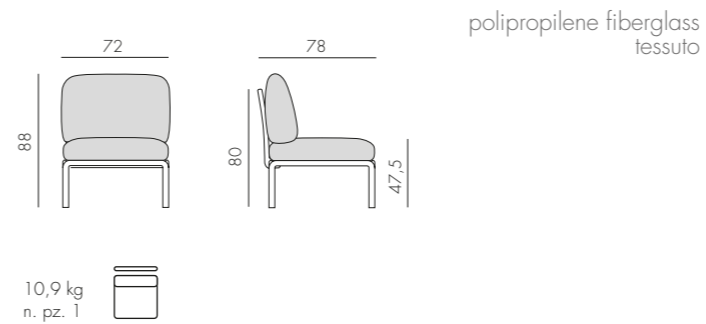

## KOMODO ELEMENTO ANGOLO

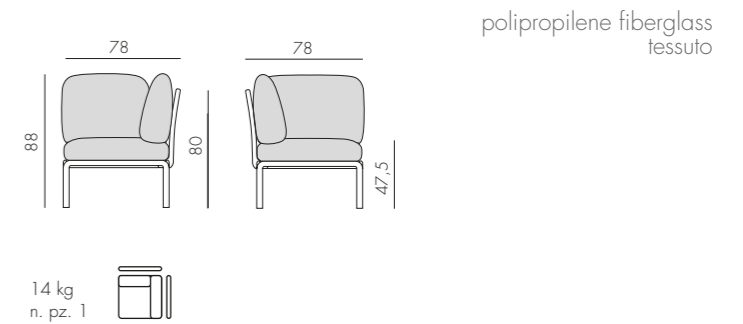

## KOMODO POUF



## KOMODO 5

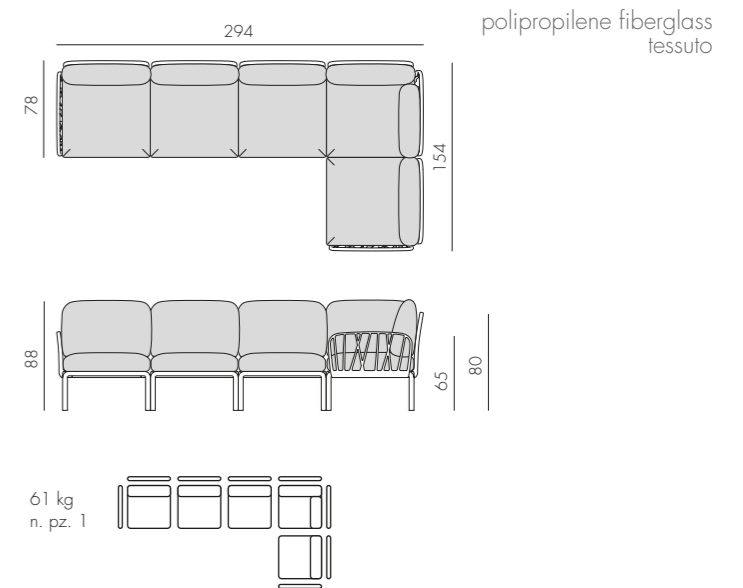

Life Cycle Assessment

For more information visit [www.nardioutdoor.com/sustainability](http://www.nardioutdoor.com/sustainability)



|                            | POLTRONA | ELEMENTO TERMINALE DX/SX | ELEMENTO CENTRALE | ELEMENTO ANGOLO | POUF         | KOMODO 5                  |
|----------------------------|----------|--------------------------|-------------------|-----------------|--------------|---------------------------|
| BIANCO<br>rosa quarzo #    |          | 40371.00.066             | 40372.00.066      | 40373.00.066    | 40374.00.066 | 40369.00.066 40370.00.066 |
| ANTRACITE<br>rosa quarzo # |          | 40371.02.066             | 40372.02.066      | 40373.02.066    | 40374.02.066 | 40369.02.066 40370.02.066 |
| TORTORA<br>rosa quarzo #   |          | 40371.10.066             | 40372.10.066      | 40373.10.066    | 40374.10.066 | 40369.10.066 40370.10.066 |
| AGAVE<br>rosa quarzo #     |          | 40371.16.066             | 40372.16.066      | 40373.16.066    | 40374.16.066 | 40369.16.066 40370.16.066 |
| BIANCO<br>grigio komodo    |          | 40371.00.172             | 40372.00.172      | 40373.00.172    | 40374.00.172 | 40369.00.172 40370.00.172 |
| ANTRACITE<br>grigio komodo |          | 40371.02.172             | 40372.02.172      | 40373.02.172    | 40374.02.172 | 40369.02.172 40370.02.172 |
| TORTORA<br>grigio komodo   |          | 40371.10.172             | 40372.10.172      | 40373.10.172    | 40374.10.172 | 40369.10.172 40370.10.172 |
| AGAVE<br>grigio komodo     |          | 40371.16.172             | 40372.16.172      | 40373.16.172    | 40374.16.172 | 40369.16.172 40370.16.172 |

# Variazioni di colore sono da ritenersi standard e naturali nei tessuti acrilici tinto filo. Posizionare in zone d'ombra - Colour variations are to be considered standard and natural in yarn-dyed acrylic fabrics. Position in shaded areas - Les variations de couleur des tissus acryliques au fil teint sont standard et naturelles. Placer dans des zones ombragées - Farbveränderungen sind als Standard und in im Garn gefärbten Acrylgeweben als natürlich zu betrachten. In schattigen Bereichen aufstellen - Las variaciones de color son normales y naturales en las telas acrílicas teñidas en hilo. Colocar en zonas de sombra - As variações de cor são consideradas standard e naturais nos tecidos acrílico tingidos com fio. Posicionar em zonas de sombra - Boyalı akrilik iplik kumaşlarda renk değişiklikleri standart ve doğal kabul edilir. Gölgeli alanlara yerleştiriniz - Изменения цвета следует считать нормой, они являются естественными в случае акриловых тканей с окрашенными волокнами. Размещать в тени



|                                       | POLTRONA | ELEMENTO TERMINALE DX/SX | ELEMENTO CENTRALE | ELEMENTO ANGOLO | POUF         | KOMODO 5                  |
|---------------------------------------|----------|--------------------------|-------------------|-----------------|--------------|---------------------------|
| BIANCO<br>adriatic<br>Sunbrella® *    |          | 40371.00.142             | 40372.00.142      | 40373.00.142    | 40374.00.142 | 40369.00.142 40370.00.142 |
| ANTRACITE<br>adriatic<br>Sunbrella® * |          | 40371.02.142             | 40372.02.142      | 40373.02.142    | 40374.02.142 | 40369.02.142 40370.02.142 |
| TORTORA<br>adriatic<br>Sunbrella® *   |          | 40371.10.142             | 40372.10.142      | 40373.10.142    | 40374.10.142 | 40369.10.142 40370.10.142 |
| AGAVE<br>adriatic<br>Sunbrella® *     |          | 40371.16.142             | 40372.16.142      | 40373.16.142    | 40374.16.142 | 40369.16.142 40370.16.142 |
| BIANCO<br>ghiaccio<br>Sunbrella® *    |          | 40371.00.138             | 40372.00.138      | 40373.00.138    | 40374.00.138 | 40369.00.138 40370.00.138 |
| ANTRACITE<br>ghiaccio<br>Sunbrella® * |          | 40371.02.138             | 40372.02.138      | 40373.02.138    | 40374.02.138 | 40369.02.138 40370.02.138 |
| TORTORA<br>ghiaccio<br>Sunbrella® *   |          | 40371.10.138             | 40372.10.138      | 40373.10.138    | 40374.10.138 | 40369.10.138 40370.10.138 |
| AGAVE<br>ghiaccio<br>Sunbrella® *     |          | 40371.16.138             | 40372.16.138      | 40373.16.138    | 40374.16.138 | 40369.16.138 40370.16.138 |

\* Trattamento laminato su richiesta con quantità minima - Laminated finish available on request with a minimum quantity - Traitement laminé sur demande avec une quantité minimum - Laminierter Ausrüstung auf Anfrage mit einer Mindestmenge - Tratamiento laminado bajo pedido con una cantidad mínima - Tratamento laminado sob encomenda com quantidade mínima - Talep üzerine minimum miktarda lamine işlem - Ламинированная обработка по запросу с минимальным количеством



|                                      |  |              |              |              |              |              |              |
|--------------------------------------|--|--------------|--------------|--------------|--------------|--------------|--------------|
| BIANCO<br>avocado<br>Sunbrella® *    |  | 40371.00.139 | 40372.00.139 | 40373.00.139 | 40374.00.139 | 40369.00.139 | 40370.00.139 |
| ANTRACITE<br>avocado<br>Sunbrella® * |  | 40371.02.139 | 40372.02.139 | 40373.02.139 | 40374.02.139 | 40369.02.139 | 40370.02.139 |
| TORTORA<br>avocado<br>Sunbrella® *   |  | 40371.10.139 | 40372.10.139 | 40373.10.139 | 40374.10.139 | 40369.10.139 | 40370.10.139 |
| AGAVE<br>avocado<br>Sunbrella® *     |  | 40371.16.139 | 40372.16.139 | 40373.16.139 | 40374.16.139 | 40369.16.139 | 40370.16.139 |

|                                      |  |              |              |              |              |              |              |
|--------------------------------------|--|--------------|--------------|--------------|--------------|--------------|--------------|
| BIANCO<br>giungla<br>Sunbrella® *    |  | 40371.00.140 | 40372.00.140 | 40373.00.140 | 40374.00.140 | 40369.00.140 | 40370.00.140 |
| ANTRACITE<br>giungla<br>Sunbrella® * |  | 40371.02.140 | 40372.02.140 | 40373.02.140 | 40374.02.140 | 40369.02.140 | 40370.02.140 |
| TORTORA<br>giungla<br>Sunbrella® *   |  | 40371.10.140 | 40372.10.140 | 40373.10.140 | 40374.10.140 | 40369.10.140 | 40370.10.140 |
| AGAVE<br>giungla<br>Sunbrella® *     |  | 40371.16.140 | 40372.16.140 | 40373.16.140 | 40374.16.140 | 40369.16.140 | 40370.16.140 |

\* Trattamento laminato su richiesta con quantità minima - Laminated finish available on request with a minimum quantity - Traitement laminé sur demande avec une quantité minimum - Lamierte Ausrüstung auf Anfrage mit einer Mindestmenge - Tratamiento laminado bajo pedido con una cantidad mínima - Tratamiento laminado sob encomenda com quantidade mínima - Talep üzerine minimum miktarda lamine işlem - Ламинированная обработка по запросу с минимальным количеством



|                                     |  |              |              |              |              |              |              |
|-------------------------------------|--|--------------|--------------|--------------|--------------|--------------|--------------|
| BIANCO<br>canvas<br>Sunbrella® *    |  | 40371.00.141 | 40372.00.141 | 40373.00.141 | 40374.00.141 | 40369.00.141 | 40370.00.141 |
| ANTRACITE<br>canvas<br>Sunbrella® * |  | 40371.02.141 | 40372.02.141 | 40373.02.141 | 40374.02.141 | 40369.02.141 | 40370.02.141 |
| TORTORA<br>canvas<br>Sunbrella® *   |  | 40371.10.141 | 40372.10.141 | 40373.10.141 | 40374.10.141 | 40369.10.141 | 40370.10.141 |
| AGAVE<br>canvas<br>Sunbrella® *     |  | 40371.16.141 | 40372.16.141 | 40373.16.141 | 40374.16.141 | 40369.16.141 | 40370.16.141 |

|                          |  |              |              |              |              |              |              |
|--------------------------|--|--------------|--------------|--------------|--------------|--------------|--------------|
| BIANCO<br>TECH panama    |  | 40371.00.131 | 40372.00.131 | 40373.00.131 | 40374.00.131 | 40369.00.131 | 40370.00.131 |
| ANTRACITE<br>TECH panama |  | 40371.02.131 | 40372.02.131 | 40373.02.131 | 40374.02.131 | 40369.02.131 | 40370.02.131 |
| TORTORA<br>TECH panama   |  | 40371.10.131 | 40372.10.131 | 40373.10.131 | 40374.10.131 | 40369.10.131 | 40370.10.131 |
| AGAVE<br>TECH panama     |  | 40371.16.131 | 40372.16.131 | 40373.16.131 | 40374.16.131 | 40369.16.131 | 40370.16.131 |

\* Trattamento laminato su richiesta con quantità minima - Laminated finish available on request with a minimum quantity - Traitement laminé sur demande avec une quantité minimum - Lamierte Ausrüstung auf Anfrage mit einer Mindestmenge - Tratamiento laminado bajo pedido con una cantidad mínima - Tratamiento laminado sob encomenda com quantidade mínima - Talep üzerine minimum miktarda lamine işlem - Ламинированная обработка по запросу с минимальным количеством

Tessuti disponibili su ordinazione per minimi quantitativi d'ordine - Fabrics available to order for minimum order quantities - Tissus disponibles sur commande de quantités minimales - Gewebe auf Bestellung für Mindestbestellmengen erhältlich - Telas disponibles bajo pedido para cantidades mínimas - Tecidos disponíveis por encomenda para quantidades mínimas de encomenda - Minimum sipariş miktarına göre sipari verilebilecek mevcut kumaşlar - ткани на заказ для минимального объема заказа.

Sunbrella®  
EXTRA \*

pp. 176



marble  
Sunbrella® .186



blue storm  
Sunbrella® .185



alpine  
Sunbrella® .182



mink brown  
Sunbrella® .183

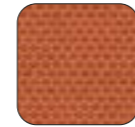

pumpkin  
Sunbrella® .184



opera  
Sunbrella® .187

Nardi  
Acrylic/Acrylic #

pp. 174



grey stone .064



artic .161

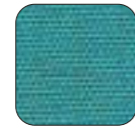

sardinia .072



denim .070



the verde .071



lime .061



felce .162



senape .069



cherry .065

# Variazioni di colore sono da ritenersi standard e naturali nei tessuti acrilici tinto filo. Posizionare in zone d'ombra - Colour variations are to be considered standard and natural in yarn-dyed acrylic fabrics. Position in shaded areas - Les variations de couleur des tissus acryliques au fil teint sont standard et naturelles. Placer dans des zones ombragées - Farbveränderungen sind als Standard und in im Garn gefärbten Acrylgeweben als natürlich zu betrachten. In schattigen Bereichen aufstellen - Las variaciones de color son normales y naturales en las telas acrílicas teñidas en hilo. Colocar en zonas de sombra - As variações de cor são consideradas standard e naturais nos tecidos acrílico tingidos com fio. Posicionar em zonas de sombra - Boyalı akrilik iplik kumaşlarda renk değişiklikleri standart ve doğal kabul edilir. Gölgeli alanlara yerleştiriniz - Изменения цвета следует считать нормой, они являются естественными в случае акриловых тканей с окрашенными волокнами. Размещать в тени

\* Trattamento laminato su richiesta con quantità minima - Laminated finish available on request with a minimum quantity - Traitement laminé sur demande avec une quantité minimum - Laminierte Ausrüstung auf Anfrage mit einer Mindestmenge - Tratamiento laminado bajo pedido con una cantidad mínima - Tratamento laminado sob encomenda com quantidade mínima - Talep üzerine minimum miktarda lamine işlem - Ламинированная обработка по запросу с минимальным количеством

## KOMODO TAVOLINO

polipropilene fiberglass

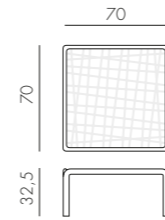

6,7 kg  
n. pz. 1



BIANCO  
40378.00.000



ANTRACITE  
40378.02.000



TORTORA  
40378.10.000



AGAVE  
40378.16.000

## KOMODO TAVOLINO VETRO

polipropilene fiberglass  
vetro

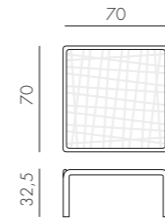

11,4 kg  
n. pz. 1



BIANCO  
vetro  
40368.00.501



ANTRACITE  
vetro  
40368.02.501



TORTORA  
vetro  
40368.10.501



AGAVE  
vetro  
40368.16.501

## KOMODO OMBRA 3 new

polipropilene fiberglass  
tessuto

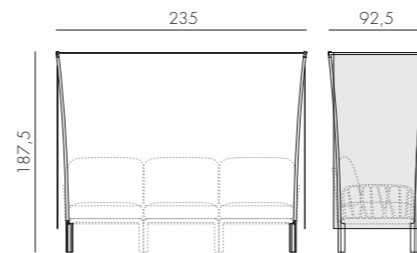

2,9 kg  
n. pz. 1

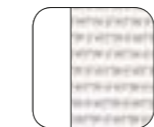

BIANCO  
velo white  
40408.00.203



ANTRACITE  
velo white  
40408.02.203



TORTORA  
velo white  
40408.10.203



AGAVE  
velo white  
40408.16.203

## KOMODO OMBRA 2 new

polipropilene fiberglass  
tessuto

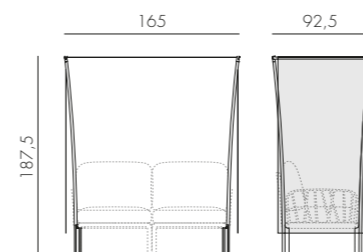

2,8 kg  
n. pz. 1



BIANCO  
velo white  
40407.00.203



ANTRACITE  
velo white  
40407.02.203



TORTORA  
velo white  
40407.10.203



AGAVE  
velo white  
40407.16.203

## KOMODO BRACCIOLO

polipropilene fiberglass

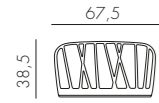

1,7 kg  
n. pz. 2



BIANCO  
40375.00.000

ANTRACITE  
40375.02.000

TORTORA  
40375.10.000

AGAVE  
40375.16.000

## KOMODO SCHIENALE

polipropilene fiberglass

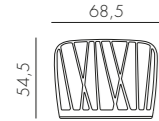

2 kg  
n. pz. 4



BIANCO  
40376.00.000

ANTRACITE  
40376.02.000

TORTORA  
40376.10.000

AGAVE  
40376.16.000

## CUSCINO SCHIENALE KOMODO

tessuto

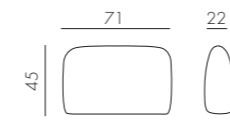

1,4 kg  
n. pz. 1

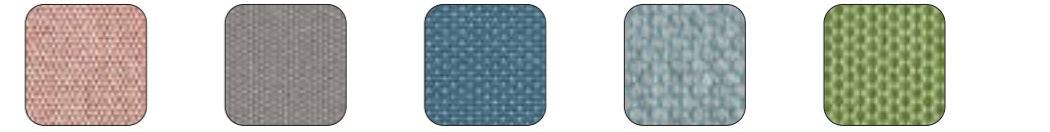

rosa quarzo #  
36370.52.066

grigio komodo  
36370.52.163

adriatic Sunbrella®\*  
36370.52.142

ghiaccio Sunbrella®\*  
36370.52.138

avocado Sunbrella®\*  
36370.52.139



giungla Sunbrella®\*  
36370.52.140

canvas Sunbrella®\*  
36370.52.141

TECH panama  
36370.52.131

Sunbrella® EXTRA▲  
pp. 176

Nardi Acrilici/Acrylic▲  
pp. 174

## CUSCINO SCHIENALE ANGOLO KOMODO

tessuto

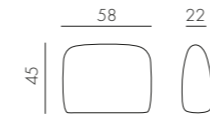

1,1 kg  
n. pz. 1



rosa quarzo #  
36370.54.066

grigio komodo  
36370.54.163

adriatic Sunbrella®\*  
36370.54.142

ghiaccio Sunbrella®\*  
36370.54.138

avocado Sunbrella®\*  
36370.54.139



giungla Sunbrella®\*  
36370.54.140

canvas Sunbrella®\*  
36370.54.141

TECH panama  
36370.54.131

Sunbrella® EXTRA▲  
pp. 176

Nardi Acrilici/Acrylic▲  
pp. 174

### ▲ Sunbrella® EXTRA - pp. 176 Nardi Acrilici/Acrylic - pp. 174

Tessuti disponibili su ordinazione per minimi quantitativi d'ordine - Fabrics available to order for minimum order quantities - Tissus disponibles sur commande de quantités minimales - Gewebe auf Bestellung für Mindestbestellmengen erhältlich - Telas disponibles bajo pedido para cantidades mínimas - Tecidos disponíveis por encomenda para quantidades mínimas de encomenda - Minimum sipariş miktarına göre sipariş verilebilecek mevcut kumaşlar - ткани на заказ для минимального объема заказа.

### # Variazioni di colore sono da ritenersi standard e naturali nei tessuti acrilici tinto filo. Posizionare in zone d'ombra - Colour variations are to be considered standard and natural in yarn-dyed acrylic fabrics. Position in shaded areas - Les variations de couleur des tissus acryliques au fil teint sont standard et naturelles. Placer dans des zones ombragées - Farbveränderungen sind als Standard und in im Garn gefärbten Acrylgeweben als natürlich zu betrachten. In schattigen Bereichen aufstellen - Las variaciones de color son normales y naturales en las telas acrílicas teñidas en hilo. Colocar en zonas de sombra - As variações de cor são consideradas standard e naturais nos tecidos acrílico tingidos com fio. Posicionar em zonas de sombra - Boyalı akrilik iplik kumaşlarda renk değişiklikleri standart ve doğal kabul edilir. Gölge alanlara yerleştiriniz - Изменения цвета следует считать нормой, они являются естественными в случае акриловых тканей с окрашенными волокнами. Размещать в тени

### \* Trattamento laminato su richiesta con quantità minima - Laminated finish available on request with a minimum quantity - Traitement laminé sur demande avec une quantité minimum - Lamierte Ausrüstung auf Anfrage mit einer Mindestmenge - Tratamiento laminado bajo pedido con una cantidad mínima - Tratamiento laminado sob encomenda com quantidade mínima - Talep üzerine minimum miktarda lamine işlem - Ламинированная обработка по запросу с минимальным количеством

DOGA RELAX **new**

polipropilene fiberglass

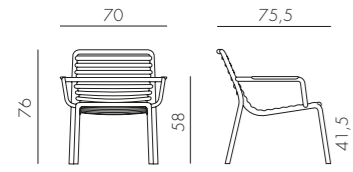

6,1 kg  
n. pz. 4



BIANCO 40256.00.000 ANTRACITE 40256.02.000 CAPPUCCINO 40256.14.000 MENTA 40256.15.000 AGAVE 40256.16.000 PERA 40256.18.000



MARSALA 40256.21.000 TABACCO 40256.53.000

DOGA BISTROT **new**

polipropilene fiberglass

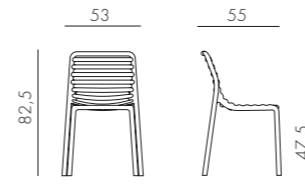

4 kg  
n. pz. 6



BIANCO 40255.00.000 ANTRACITE 40255.02.000 CAPPUCCINO 40255.14.000 MENTA 40255.15.000 AGAVE 40255.16.000 PERA 40255.18.000



MARSALA 40255.21.000 TABACCO 40255.53.000

DOGA ARMCHAIR **new**

polipropilene fiberglass

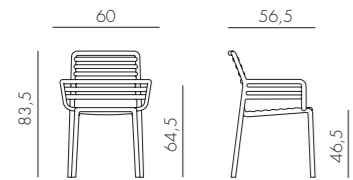

4,8 kg  
n. pz. 6



BIANCO 40254.00.000 ANTRACITE 40254.02.000 CAPPUCCINO 40254.14.000 MENTA 40254.15.000 AGAVE 40254.16.000 PERA 40254.18.000



MARSALA 40254.21.000 TABACCO 40254.53.000

## TRILL ARMCHAIR



polipropilene fiberglass

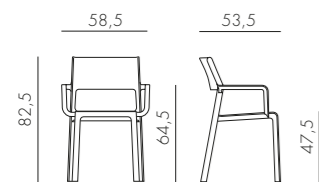

4,7 kg  
n. pz. 6



BIANCO 40250.00.000 ANTRACITE 40250.02.000 GRIGIO 40250.03.000 ROSA BOUQUET 40250.08.000 TORTORA 40250.10.000 AGAVE 40250.16.000



OTTANIO 40250.49.000 TABACCO 40250.53.000 SENAPE 40250.56.000

## TRILL BISTROT

polipropilene fiberglass

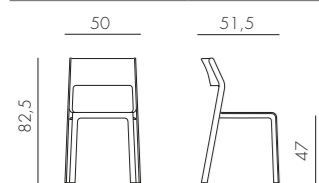

4,2 kg  
n. pz. 6



BIANCO 40253.00.000 ANTRACITE 40253.02.000 GRIGIO 40253.03.000 ROSA BOUQUET 40253.08.000 TORTORA 40253.10.000 AGAVE 40253.16.000



OTTANIO 40253.49.000 TABACCO 40253.53.000 SENAPE 40253.56.000

## TRILL STOOL

polipropilene fiberglass

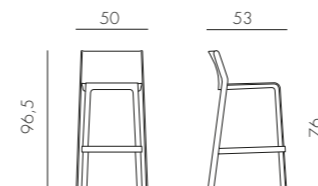

5,1 kg  
n. pz. 4



BIANCO 40350.00.000 ANTRACITE 40350.02.000 GRIGIO 40350.03.000 ROSA BOUQUET 40350.08.000 TORTORA 40350.10.000 AGAVE 40350.16.000



OTTANIO 40350.49.000 TABACCO 40350.53.000 SENAPE 40350.56.000

## TRILL STOOL MINI

polipropilene fiberglass

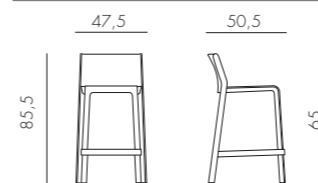

4,8 kg  
n. pz. 4



BIANCO 40353.00.000 ANTRACITE 40353.02.000 GRIGIO 40353.03.000 ROSA BOUQUET 40353.08.000 TORTORA 40353.10.000 AGAVE 40353.16.000



OTTANIO 40353.49.000 TABACCO 40353.53.000 SENAPE 40353.56.000



### Life Cycle Assessment

For more information visit [www.nardioutdoor.com/sustainability](http://www.nardioutdoor.com/sustainability)



## NET BENCH

polipropilene fiberglass

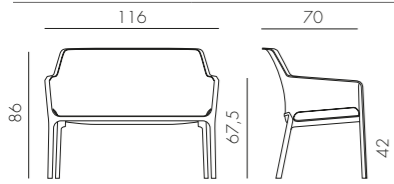

8,9 kg  
n. pz. 20



BIANCO 40338.00.000 ANTRACITE 40338.02.000 SALICE 40338.04.000 TORTORA 40338.10.000 SENAPE 40338.56.000 CORALLO 40338.75.000

## NET RELAX

polipropilene fiberglass

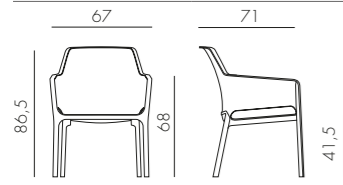

4,9 kg  
n. pz. 4



pz. 6



BIANCO 40327.00.000 ANTRACITE 40327.02.000 SALICE 40327.04.000 TORTORA 40327.10.000 SENAPE 40327.56.000 CORALLO 40327.75.000

## NET

polipropilene fiberglass

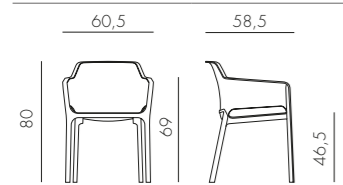

3,9 kg  
n. pz. 6



pz. 6



BIANCO 40326.00.000.06 ANTRACITE 40326.02.000.06 SALICE 40326.04.000.06 TORTORA 40326.10.000.06 SENAPE 40326.56.000.06 CORALLO 40326.75.000.06

## BIT

polipropilene fiberglass

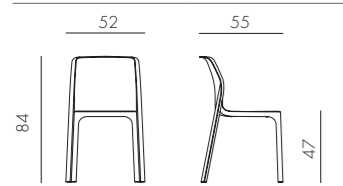

3,5 kg  
n. pz. 6



BIANCO 40328.00.000.06 ANTRACITE 40328.02.000.06 SALICE 40328.04.000.06 TORTORA 40328.10.000.06 SENAPE 40328.56.000.06 CORALLO 40328.75.000.06

## NET STOOL

polipropilene fiberglass

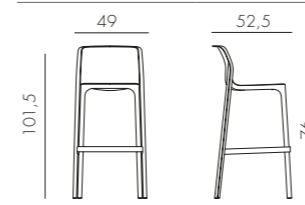

4,4 kg  
n. pz. 4



BIANCO 40355.00.000 ANTRACITE 40355.02.000 SALICE 40355.04.000 TORTORA 40355.10.000 SENAPE 40355.56.000 CORALLO 40355.75.000

## NET STOOL MINI

polipropilene fiberglass

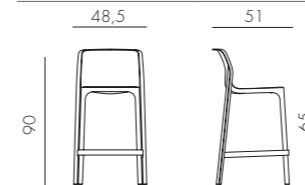

4,2 kg  
n. pz. 4



BIANCO 40356.00.000 ANTRACITE 40356.02.000 SALICE 40356.04.000 TORTORA 40356.10.000 SENAPE 40356.56.000 CORALLO 40356.75.000

## PALMA

polipropilene

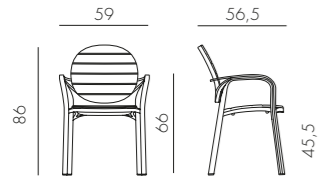

5,2 kg  
n. pz. 6



BIANCO 40237.00.000  
BIANCO TORTORA 40237.00.010  
ANTRACITE 40237.02.002  
CAFFÈ 40237.05.005  
TORTORA 40237.10.010

## ERICA

polipropilene

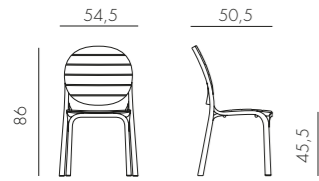

4,2 kg  
n. pz. 22



BIANCO 40236.00.000  
BIANCO TORTORA 40236.00.010  
ANTRACITE 40236.02.002  
CAFFÈ 40236.05.005  
TORTORA 40236.10.010

## NINFEA DINNER

polipropilene  
alluminio

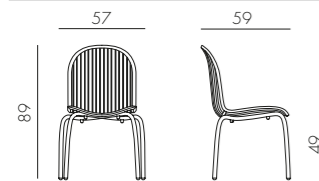

4,5 kg  
n. pz. 6



ANTRACITE vernic. antracite 62052.02.000  
BIANCO vernic. bianco 62053.00.000

## NINFEA RELAX

polipropilene  
alluminio

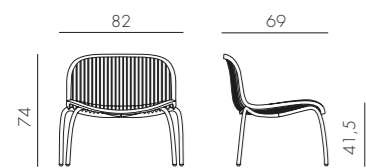

7,2 kg  
n. pz. 2



ANTRACITE vernic. antracite 62252.02.000  
BIANCO vernic. bianco 62253.00.000

## ARIA (POLTRONA ARIA + CUSCINO SEDUTA + CUSCINO ARREDO)

polipropilene  
tessuto

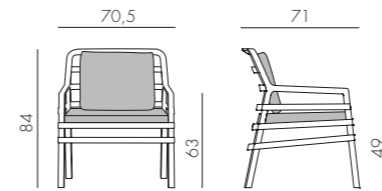

7,9 kg  
n. pz. 1

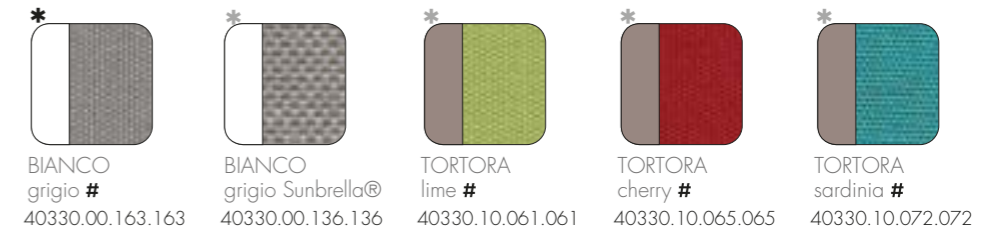

\* Disponibile a magazzino  
Available ex-stock  
Disponibile sur stock  
Ab Lager verfügbar  
Disponibile en almacén habitualmente  
Disponível em estoque  
Stokta mevcut  
Наличие на складе

\* Disponibile su ordine  
Available to order  
Disponibile sur commande  
Mit Auftrag verfügbar  
Disponibile sólo sobre pedido  
Disponível sob encomenda  
Sipariş göre hazırlanacaktır  
Под заказ

## ARIA FIT (POLTRONA ARIA + CUSCINO SEDUTA + CUSCINO FIT)

polipropilene  
tessuto

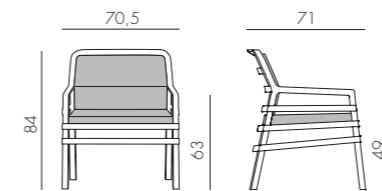

7,9 kg  
n. pz. 1

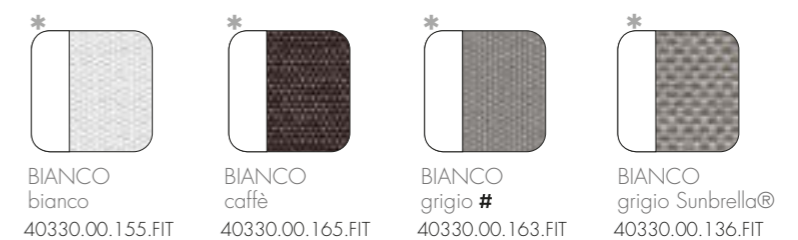

\* Disponibile su ordine  
Available to order  
Disponibile sur commande  
Mit Auftrag verfügbar  
Disponibile sólo sobre pedido  
Disponível sob encomenda  
Sipariş göre hazırlanacaktır  
Под заказ

# Variazioni di colore sono da ritenersi standard e naturali nei tessuti acrilici tinto filo. Posizionare in zone d'ombra - Colour variations are to be considered standard and natural in yarn-dyed acrylic fabrics. Position in shaded areas - Les variations de couleur des tissus acryliques au fil teint sont standard et naturelles. Placer dans des zones ombragées - Farbveränderungen sind als Standard und in im Garn gefärbten Acrylgeweben als natürlich zu betrachten. In schattigen Bereichen aufstellen - Las variaciones de color son normales y naturales en las telas acrílicas teñidas en hilo. Colocar en zonas de sombra - As variações de cor são consideradas standard e naturais nos tecidos acrílico tingidos com fio. Posicionar em zonas de sombra - Boyalı akrilik iplik kumaşlarda renk değişiklikleri standart ve doğal kabul edilir. Gölge alanlara yerleştiriniz - Изменения цвета следует считать нормой, они являются естественными в случае акриловых тканей с окрашенными волокнами. Размещать в тени

## ATLANTICO

polipropilene fiberglass  
tessuto sintetico

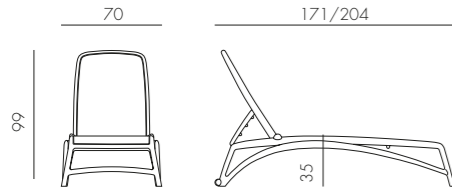

16 kg  
n. pz. 20

Tessuto ricambiabile  
Replaceable fabric  
Tissu changeable  
Auswechselbarer Stoff  
Tela sustituible  
Tecidos recambiables  
Değiştirilebilen Kumaş  
Съемная ткань



## RICAMBIO ATLANTICO

resina acetlica  
tessuto sintetico

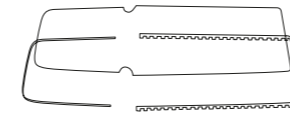

1,3 kg  
n. pz. 1

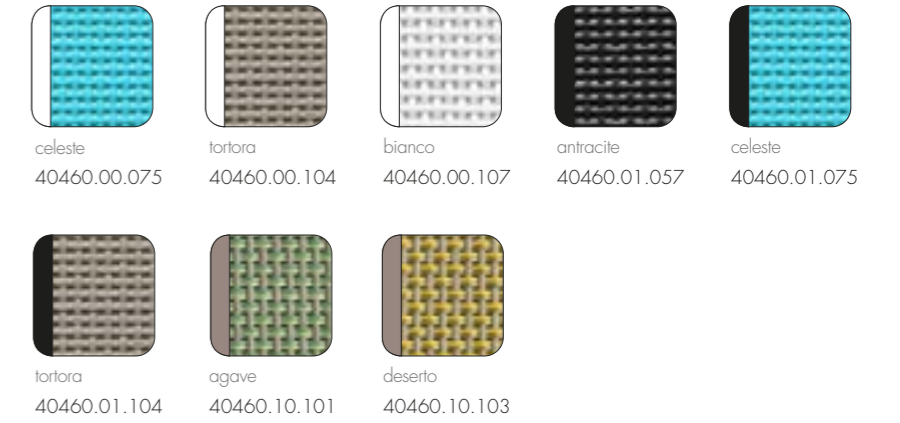

## BRACCIOLO ATLANTICO

polipropilene fiberglass

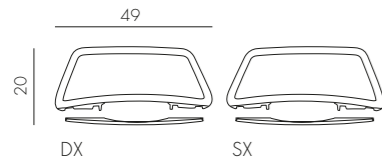

1,1 kg  
n. pz. 1

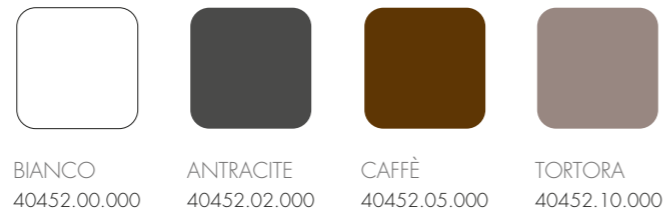

# RIO - RIO ALU

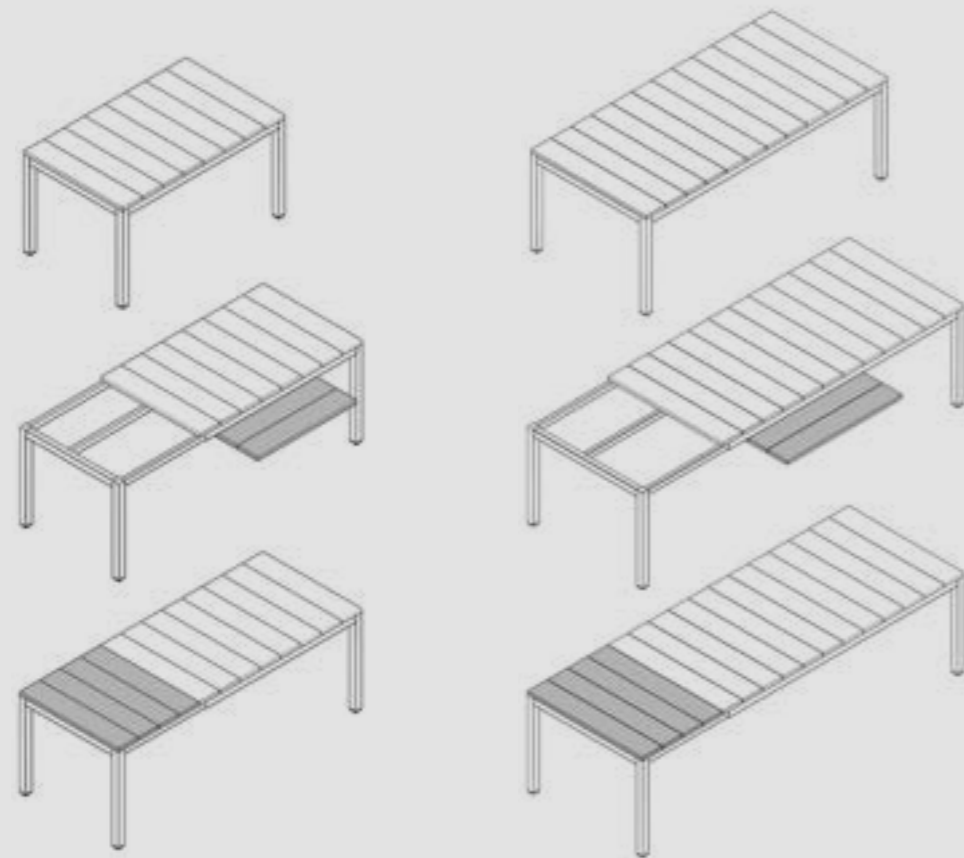

rio 140 extensibile  
6/8 🧑 140/210x85x76 cm

rio 210 extensibile  
8/10 🧑 210/280x100x76 cm

rio Alu 140 extensibile  
6/8 🧑 140/210x85x75 cm

rio Alu 210 extensibile  
8/10 🧑 210/280x100x75 cm

## RIO ALU 210 EXTENSIBLE 8/10 🧑

alluminio

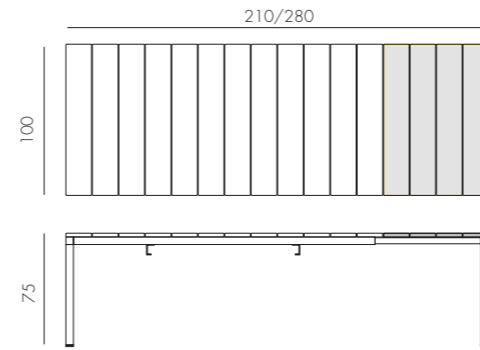

54 kg  
n. pz. 1

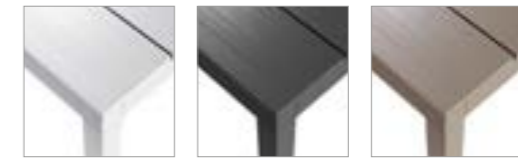

verniciato bianco  
48853.00.000

verniciato antracite  
48852.02.000

verniciato tortora  
48859.10.000

## RIO ALU 140 EXTENSIBLE 6/8 🧑

alluminio

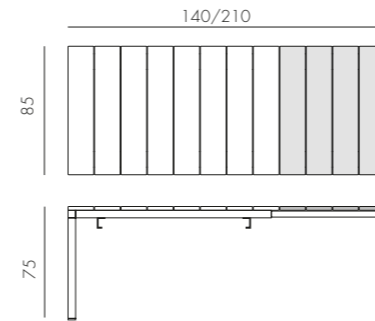

37,1 kg  
n. pz. 1

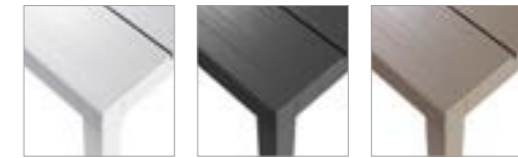

verniciato bianco  
48653.00.000

verniciato antracite  
48652.02.000

verniciato tortora  
48659.10.000

## SET RIO BENCH ALU **new**

alluminio

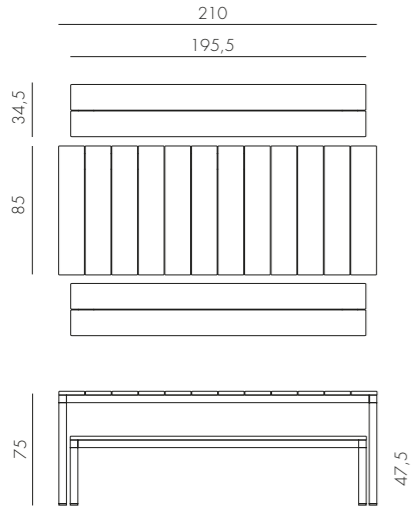

verniciato bianco 49253.00.000  
verniciato antracite 49252.02.000  
verniciato tortora 49259.10.000

72 kg  
n. pz. 3

Il set comprende 1 Rio Alu 210 Fix e 2 Rio Bench Alu  
The set includes 1 Rio Alu 210 Fix and 2 Rio Bench Alu  
L'ensemble comprend 1 Rio Alu 210 Fix et 2 Rio Bench Alu  
Die Garnitur umfasst 1 Rio Alu 210 Fix und 2 Rio Bench Alu

El juego incluye 1 Rio Alu 210 Fix y 2 Rio Bench Alu  
O conjunto inclui 1 Rio Alu 210 Fix e 2 Rio Bench Alu  
Set içeriğinde 1 Rio Alu 210 Fix ve 2 Rio Bench Alu mevcuttur  
Комплект состоит из 1 Rio Alu 210 Fix и 2 Rio Bench Alu

## RIO BENCH ALU **new**

alluminio

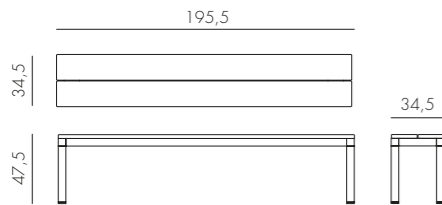

verniciato bianco 49053.00.000  
verniciato antracite 49052.02.000  
verniciato tortora 49059.10.000

17,5 kg  
n. pz. 1

## RIO ALU 210 FIX **new**

alluminio

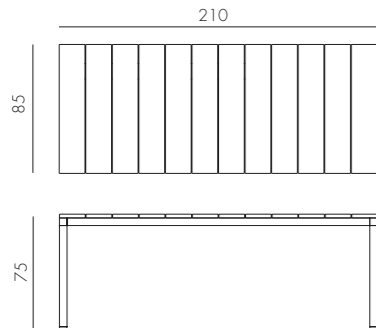

verniciato bianco 49153.00.000  
verniciato antracite 49152.02.000  
verniciato tortora 49159.10.000

37 kg  
n. pz. 1

## RIO 210 EXTENSIBLE 8/10

durelTOP - polipropilene  
alluminio

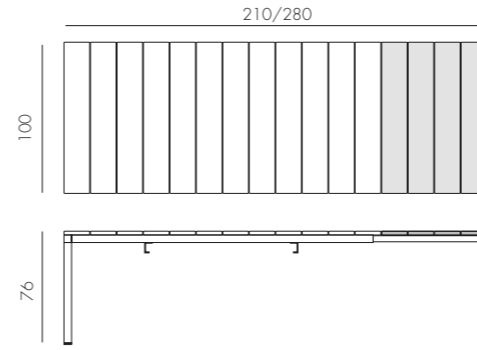

BIANCO verniciato bianco 48253.00.000  
ANTRACITE\* verniciato antracite 48252.02.000  
TORTORA verniciato tortora 48259.10.000

49 kg  
n. pz. 1

## RIO 140 EXTENSIBLE 6/8

durelTOP - polipropilene  
alluminio

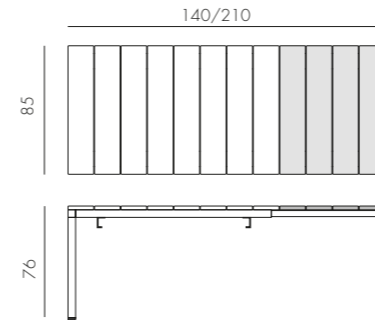

BIANCO verniciato bianco 48353.00.000  
ANTRACITE\* verniciato antracite 48352.02.000  
TORTORA verniciato tortora 48359.10.000

32,6 kg  
n. pz. 1

\* Posizionare in zone d'ombra - Position in shaded areas - Placer dans des zones ombragées - In schattigen Bereichen aufstellen - Colocar en zonas de sombra - Posicionar em zonas de sombra - Gölgele alanlara yerleştiriniz - Размещать в тени

# ALLORO

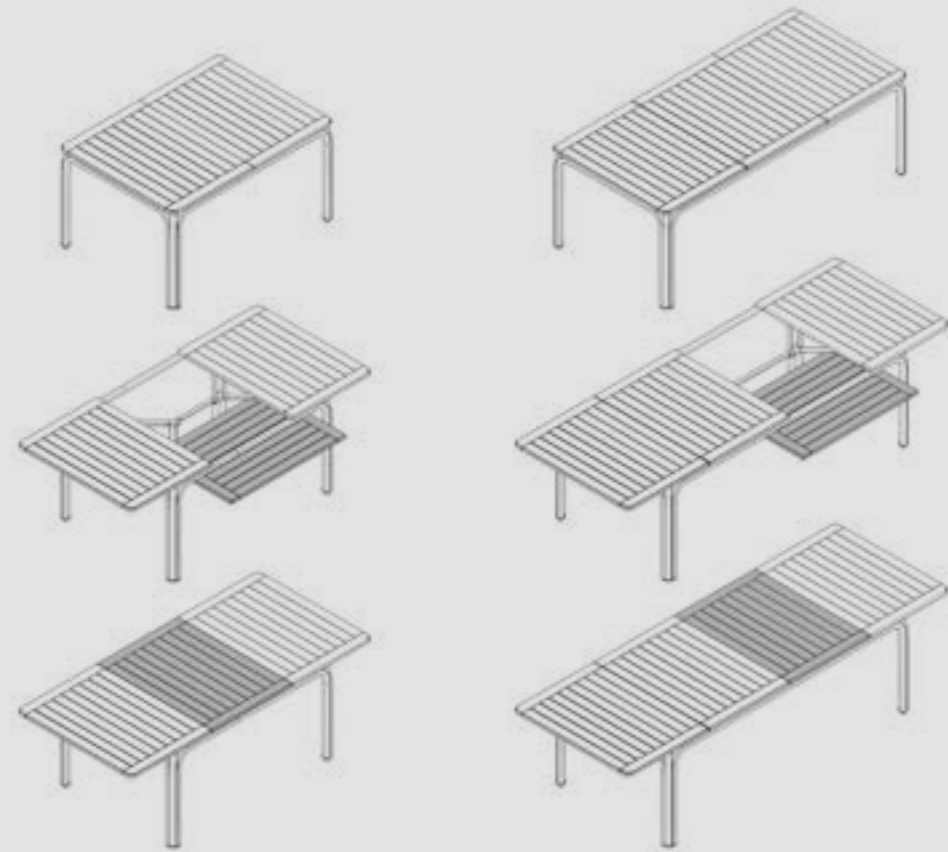

alloro 140 extensible  
6/8 🧑 140/210x100x73 cm

alloro 210 extensible  
8/10 🧑 210/280x100x73 cm

## ALLORO 210 EXTENSIBLE 8/10 🧑

durelTOP - polipropilene  
alluminio

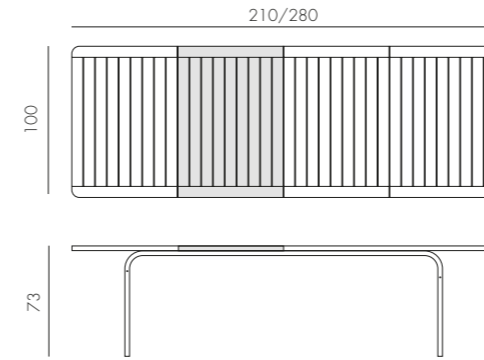

44,5 kg  
n. pz. 1

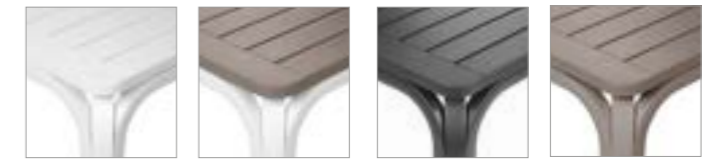

BIANCO  
verniciato bianco  
42853.00.000

TORTORA  
verniciato bianco  
42853.10.000

ANTRACITE\*  
verniciato antracite  
42852.02.000

TORTORA  
verniciato tortora  
42859.10.000

## ALLORO 140 EXTENSIBLE 6/8 🧑

durelTOP - polipropilene  
alluminio

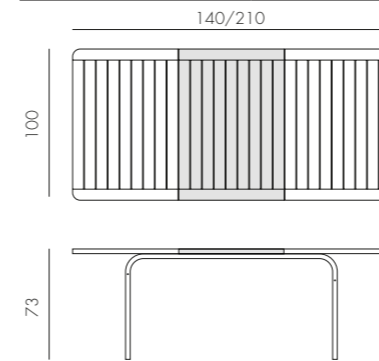

33,7 kg  
n. pz. 1

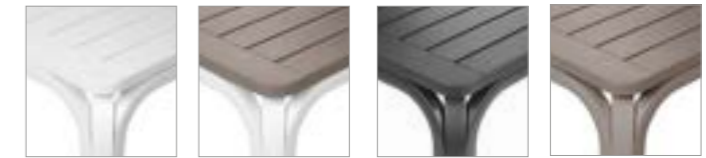

BIANCO  
verniciato bianco  
42753.00.000

TORTORA  
verniciato bianco  
42753.10.000

ANTRACITE\*  
verniciato antracite  
42752.02.000

TORTORA  
verniciato tortora  
42759.10.000

\* Posizionare in zone d'ombra - Position in shaded areas - Placer dans des zones ombragées - In schattigen Bereichen aufstellen - Colocar en zonas de sombra - Posicionar em zonas de sombra - Gölge alanlara yerleştiriniz - Размещать в тени

## LOTO DINNER 190

vetro  
alluminio

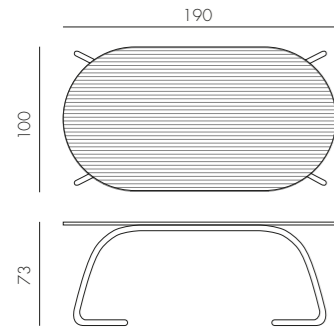

ANTRACITE  
verniciato antracite  
44052.02.000

BIANCO  
verniciato bianco  
44053.00.000

49,8 kg  
n. pz. 1

## LOTO DINNER Ø170

vetro  
alluminio

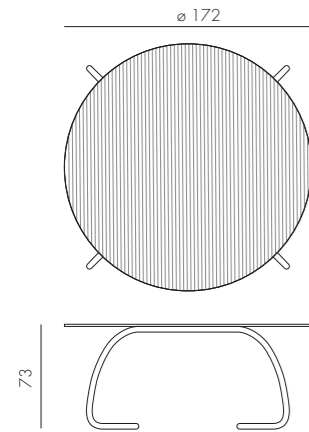

ANTRACITE  
verniciato antracite  
44452.02.000



BIANCO  
verniciato bianco  
44453.00.000

65,3 kg  
n. pz. 1

## LOTO RELAX 95

vetro  
alluminio

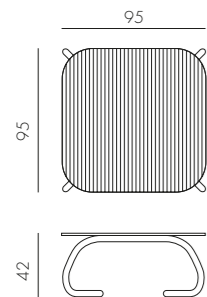

ANTRACITE  
verniciato antracite  
44752.02.000



BIANCO  
verniciato bianco  
44753.00.000

27 kg  
n. pz. 1

## LOTO RELAX 60

laminato  
alluminio

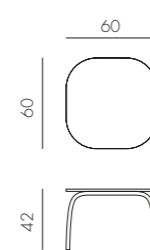

ANTRACITE \*  
verniciato antracite  
44652.00.303



BIANCO  
verniciato bianco  
44653.00.301

5 kg  
n. pz. 1

## CUBE 140X80

durelTOP - polipropilene  
alluminio

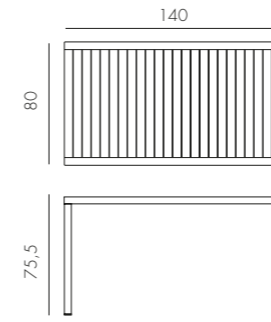

BIANCO  
verniciato bianco  
47753.00.000

ANTRACITE \*  
verniciato antracite  
47752.02.000

CAFFÈ \*  
verniciato caffè  
47757.05.000

TORTORA  
verniciato tortora  
47759.10.000

16,9 kg  
n. pz. 1

## CUBE 80

durelTOP - polipropilene  
alluminio

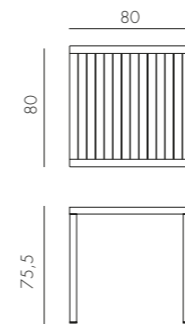

BIANCO  
verniciato bianco  
48053.00.000



ANTRACITE  
verniciato antracite  
48052.02.000



CAFFÈ  
verniciato caffè  
48057.05.000



TORTORA  
verniciato tortora  
48059.10.000

11,5 kg  
n. pz. 1

## CUBE 70

durelTOP - polipropilene  
alluminio

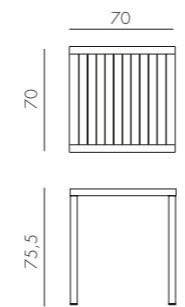

BIANCO  
verniciato bianco  
47853.00.000



ANTRACITE  
verniciato antracite  
47852.02.000



CAFFÈ  
verniciato caffè  
47857.05.000



TORTORA  
verniciato tortora  
47859.10.000

9,5 kg  
n. pz. 1

\* Posizionare in zone d'ombra - Position in shaded areas - Placer dans des zones ombragées - In schattigen Bereichen aufstellen - Colocar en zonas de sombra - Posicionar em zonas de sombra - Gölge alanlara yerleştiriniz - Размещать в тени

\* Posizionare in zone d'ombra - Position in shaded areas - Placer dans des zones ombragées - In schattigen Bereichen aufstellen - Colocar en zonas de sombra - Posicionar em zonas de sombra - Gölge alanlara yerleştiriniz - Размещать в тени

DOGA TABLE **new**

polipropilene fiberglass

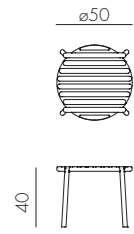

2,4 kg  
n. pz. 4



NET TABLE 100

polipropilene fiberglass

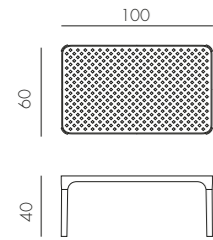

6,3 kg  
n. pz. 1



ARIA TAVOLINO 100

polipropilene

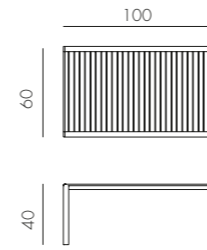

8 kg  
n. pz. 1



ARIA TAVOLINO 60

polipropilene



5 kg  
n. pz. 1



POP

polipropilene fiberglass

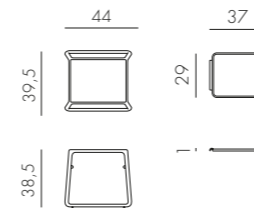

2,5 kg  
n. pz. 4





# regeneration

*Our commitment to making environmentally sustainable products, with high added value led us to launch the Regeneration industrial programme, in 2019, for the production of outdoor furniture in recycled plastic.*

*We make our products at a production plant designed with cutting-edge plant engineering technology. It is equipped with energy-saving hybrid injection presses, with an air-based cooling system without using water and consuming very little electricity. Most of the electricity used is produced by a photovoltaic panel system.*

*Regeneration is much more than a simple line of recycled plastic products. It allows us to experiment with solutions that can be applied on a large scale to the entire production cycle and involves all steps, from the concept creation of individual furniture items to their packaging.*

*For the Regeneration line, all protective packaging and related internal supports are made of FSC-certified recycled cardboard and fully recyclable low-density polyethylene, both designed to minimise their use.*

*Lastly, every day we strive to gradually implement actions to improve our environmental performance by means of LCA (Life Cycle Assessment) analysis, an analytical and systematic methodology that assesses the environmental footprint of our new products throughout their entire life cycle.*

For more information visit [www.nardioutdoor.com/regeneration](http://www.nardioutdoor.com/regeneration)

# regeneration

Il nostro impegno nel realizzare prodotti dall'alto valore aggiunto e sostenibili per l'ambiente ci ha portati a inaugurare nel 2019 il programma industriale Regeneration per la produzione di arredi per esterno in plastica riciclata.

Li facciamo in uno stabilimento progettato con tecnologie all'avanguardia a livello impiantistico, dotato di presse a iniezione ibride ad alto risparmio energetico nelle quali il sistema di raffreddamento utilizza l'aria senza impiegare acqua e consumando pochissima energia elettrica. Quest'ultima è generata, in gran parte, da un sistema di pannelli fotovoltaici.

Regeneration è molto più di una semplice linea di prodotti in plastica riciclata e ci permette di sperimentare soluzioni applicabili su larga scala a tutto il ciclo produttivo coinvolgendo tutte le fasi, dall'ideazione dei singoli arredi fino al loro imballaggio.

Per quest'ultimo aspetto per la linea Regeneration tutti gli imballi di protezione e i relativi sostegni interni sono in cartone riciclato certificato FSC e polietilene a bassa densità completamente riciclabile, entrambi progettati in modo da ridurre al minimo il loro impiego.

Infine, ci impegniamo ogni giorno a mettere progressivamente in atto azioni per migliorare le nostre performance ambientali grazie alle analisi LCA (Life Cycle Assessment), metodologia analitica e sistematica che valuta l'impronta ambientale dei nostri nuovi prodotti lungo il loro intero ciclo di vita.

Per maggiori informazioni visita [www.nardioutdoor.com/regeneration](http://www.nardioutdoor.com/regeneration)

# SIPARIO

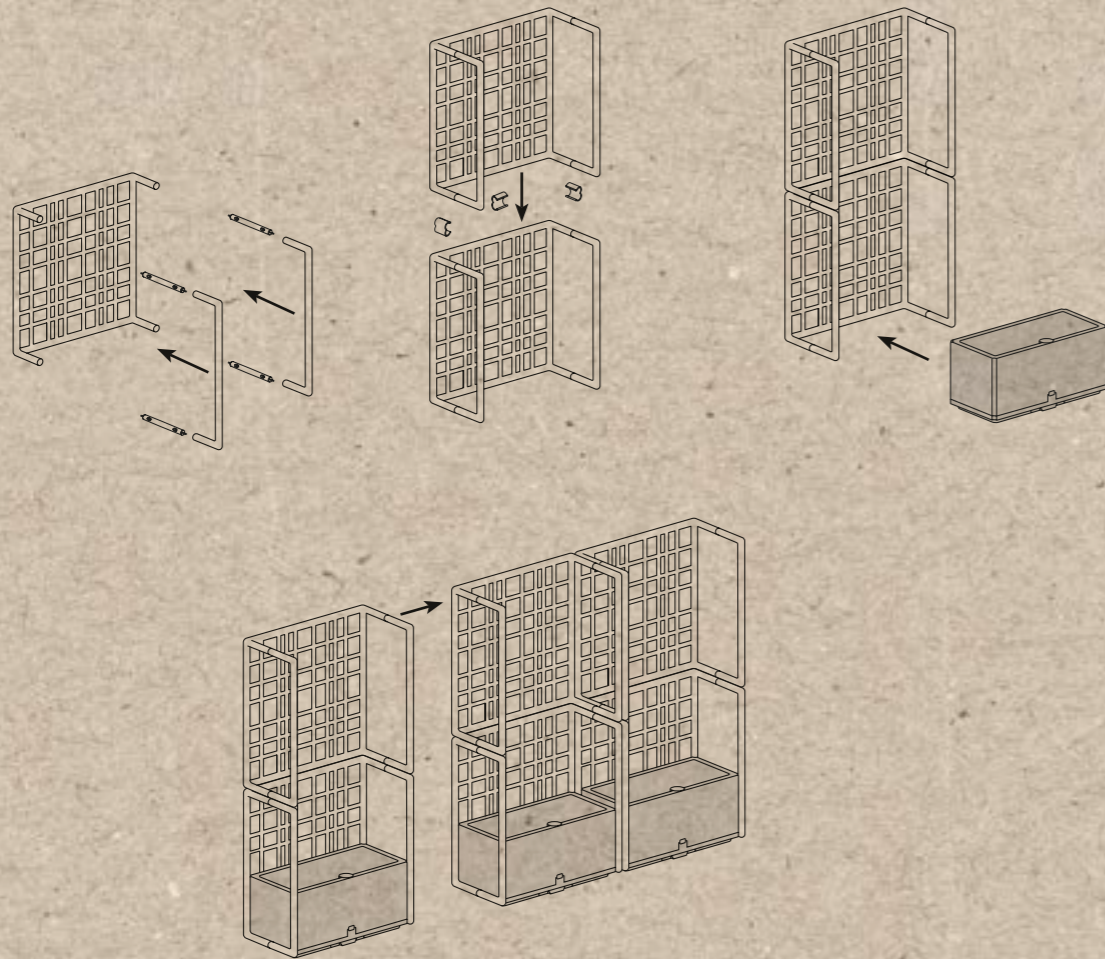

SIPARIO è un divisorio modulare autoportante da esterno configurabile a piacere, ideale per dividere gli spazi aperti. È costituito da elementi grigliati facilmente agganciabili tra loro senza l'uso di viti e dotato di vaso contenitore per piante. È realizzato in plastica rigenerata

*SIPARIO, a free-standing modular partition for outdoor use, can be configured as required and is ideal for separating open spaces. It consists of grid elements, easily hooked together without using screws, and includes a container for plants. It's made of regenerated plastic*

## regeneration

### SIPARIO 3

polipropilene fiberglass rigenerato

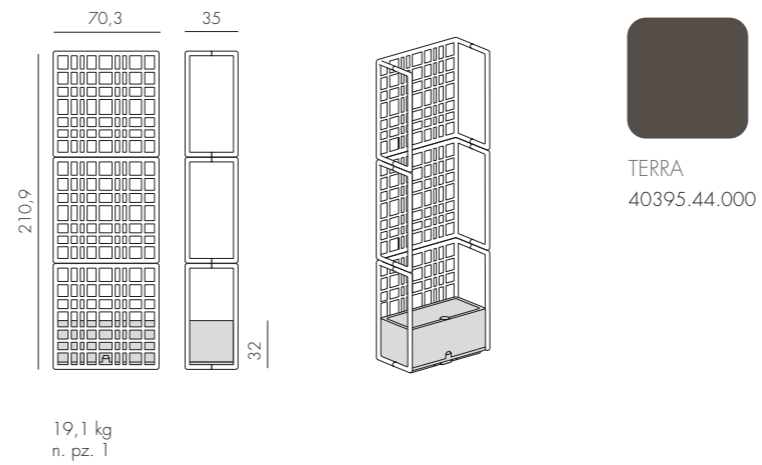

### SIPARIO 2



polipropilene fiberglass rigenerato

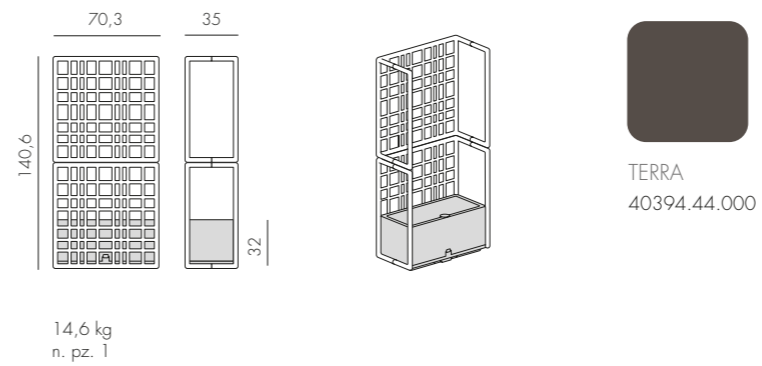

### SIPARIO MODULO

polipropilene fiberglass rigenerato

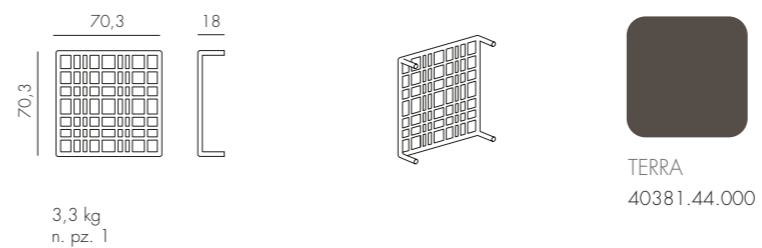

Il polipropilene fiberglass rigenerato può subire delle variazioni di colore dovute all'utilizzo di materiale riciclato - Regenerated fiberglass polypropylene may undergo variations in color due to the use of recycled material - Polypropylène fiberglass régénérée peut subir variations de couleur en raison de l'utilisation de matériaux recyclés - Regeneriertem fiberglass-Polypropylen kann aufgrund der Verwendung von recyceltem Material Farbabweichungen unterliegen - El polipropileno fiberglass regenerado puede sufrir variaciones de color debido al uso de material reciclado - O polipropileno fiberglass regenerado pode sofrer variações de cor devido ao uso de material reciclado - Rejenered edilmis polipropilen fiberglass, geri dönüşüm malzemesi kullanımı nedeniyle renk değişikliklerine maruz kalabilir - Цвет регенерированного полипропиленового стекловолокна может претерпевать изменения вследствие использования переработанного материала.



**Life Cycle Assessment**

For more information visit [www.nardioutdoor.com/sustainability](http://www.nardioutdoor.com/sustainability)

## SIPARIO VASO

polipropilene fiberglass rigenerato

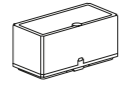
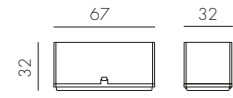

TERRA  
40382.44.000

6,4 kg  
n. pz. 1

## SIPARIO CHIUSURA

polipropilene fiberglass rigenerato

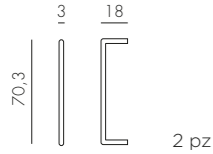

TERRA  
40383.44.000

1 kg  
n. pz. 1

## SIPARIO KIT CLIPS

polipropilene fiberglass rigenerato



TERRA  
40392.44.000

0,4 kg  
n. pz. 1

accessori  
*accessories*

Il polipropilene fiberglass rigenerato può subire delle variazioni di colore dovute all'utilizzo di materiale riciclato - Regenerated fiberglass polypropylene may undergo variations in color due to the use of recycled material - Polypropylène fiberglass régénérée peut subir variations de couleur en raison de l'utilisation de matériaux recyclés - Regeneriertem fiberglass-Polypropylen kann aufgrund der Verwendung von recyceltem Material Farbabweichungen unterliegen - El polipropileno fiberglass regenerado puede sufrir variaciones de color debido al uso de material reciclado - O polipropileno fiberglass regenerado pode sofrer variações de cor devido ao uso de material reciclado - Rejenere edilmiş polipropilen fiberglass, geri dönüşüm malzemesi kullanımı nedeniyle renk değişikliklerine maruz kalabilir - Цвет регенерированного полипропиленового стекловолокна может претерпевать изменения вследствие использования переработанного материала.

## CUSCINO DOGA RELAX **new**

tessuto

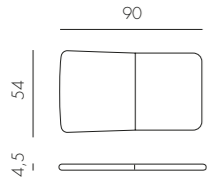

lino  
36256.00.152

0,7 kg  
n. pz. 4

## CUSCINO DOGA ARMCHAIR **new**

tessuto

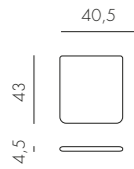

lino  
36254.00.152

0,3 kg  
n. pz. 4

## CUSCINO DOGA BISTROT **new**

tessuto

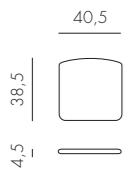

lino  
36255.00.152

0,25 kg  
n. pz. 4

## CUSCINO TRILL

tessuto

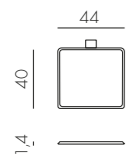

cenere  
36253.00.132

Solo per sedia Trill Bistrot - Only for Trill Bistrot chair  
- Seulement pour la chaise Trill Bistrot - Nur für Trill  
Bistrot Stuhl - Sólo para silla Trill Bistrot - Apenas  
para cadeira Trill Bistrot - Sadece Trill Bistrot san-  
dalyesi için - Только для кресла Trill Bistrot.

0,2 kg  
n. pz. 4

## CUSCINO NET BENCH

tessuto

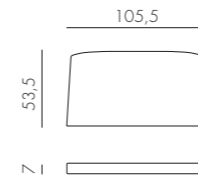

1,5 kg  
n. pz. 4



grey stone #  
36338.00.064



rosa quarzo #  
36338.00.066



senape #  
36338.00.069



denim #  
36338.00.070



the verde #  
36338.00.071



sardinia #  
36338.00.072



bianco  
36338.00.155



grigio #  
36338.00.163



grigio Sunbrella®\*  
36338.00.136

## CUSCINO NET RELAX

tessuto

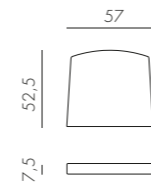

0,8 kg  
n. pz. 4



grey stone #  
36327.00.064



rosa quarzo #  
36327.00.066



senape #  
36327.00.069



denim #  
36327.00.070



the verde #  
36327.00.071



sardinia #  
36327.00.072



bianco  
36327.00.155



grigio #  
36327.00.163



grigio Sunbrella®\*  
36327.00.136

# Variazioni di colore sono da ritenersi standard e naturali nei tessuti acrilici tinto filo. Posizionare in zone d'ombra - Colour variations are to be considered standard and natural in yarn-dyed acrylic fabrics. Position in shaded areas - Les variations de couleur des tissus acryliques au fil teint sont standard et naturelles. Placer dans des zones ombragées - Farbveränderungen sind als Standard und in im Garn gefärbten Acrylgeweben als natürlich zu betrachten. In schattigen Bereichen aufstellen - Las variaciones de color son normales y naturales en las telas acrílicas teñidas en hilo. Colocar en zonas de sombra - As variações de cor são consideradas standard e naturais nos tecidos acrílico tingidos com fio. Posicionar em zonas de sombra - Boyalı akrilik iplik kumaşlarda renk değişiklikleri standart ve doğal kabul edilir. Gölge alanlara yerleştiriniz - Изменения цвета следует считать нормой, они являются естественными в случае акриловых тканей с окрашенными волокнами. Размещать в тени

\* Trattamento laminato su richiesta con quantità minima - Laminated finish available on request with a minimum quantity - Traitement laminé sur demande avec une quantité minimum - Lamierte Ausrüstung auf Anfrage mit einer Mindestmenge - Tratamiento laminado bajo pedido con una cantidad mínima - Tratamiento laminado sob encomenda com quantidade mínima - Talep üzerine minimum miktarda lamine işlem - Ламинированная обработка по запросу с минимальным количеством

## CUSCINO SHELL (NET RELAX)

tessuto

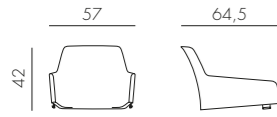

2,2 kg  
n. pz. 2



rosa quarzo #  
36327.01.066

denim #  
36327.01.070

grigio #  
36327.01.163

Utilizzabile solo con cuscino Net Relax - Can only be used with Net Relax cushion - À utiliser uniquement avec le coussin Net Relax - Kann nur mit Net Relax Kissen verwendet werden - Se puede utilizar sólo con el cojín Net Relax - Só pode ser usada em conjunto com almofada de assento Net Relax - Sadece Net Relax minderiyile kullanılmalı - Можно использовать только с подушкой Net Relax.

## CUSCINO NET

tessuto

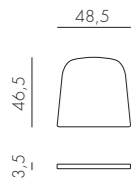

0,3 kg  
n. pz. 4

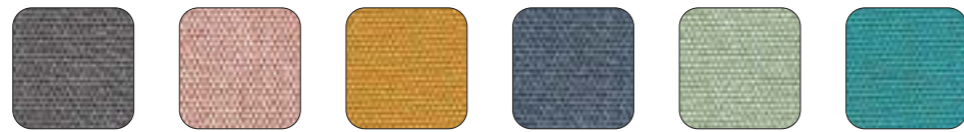

grey stone #  
36326.00.064

rosa quarzo #  
36326.00.066

senape #  
36326.00.069

denim #  
36326.00.070

the verde #  
36326.00.071

sardinia #  
36326.00.072



bianco  
36326.00.155

grigio #  
36326.00.163

grigio Sunbrella\*  
36326.00.136

## CUSCINO BIT new

tessuto

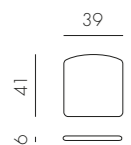

0,3 kg  
n. pz. 4



grigio #  
36328.00.163

# Variazioni di colore sono da ritenersi standard e naturali nei tessuti acrilici tinto filo. Posizionare in zone d'ombra - Colour variations are to be considered standard and natural in yarn-dyed acrylic fabrics. Position in shaded areas - Les variations de couleur des tissus acryliques au fil teint sont standard et naturelles. Placer dans des zones ombragées - Farbveränderungen sind als Standard und in im Garn gefärbten Acrylgeweben als natürlich zu betrachten. In schattigen Bereichen aufstellen - Las variaciones de color son normales y naturales en las telas acrílicas teñidas en hilo. Colocar en zonas de sombra - As variações de cor são consideradas standard e naturais nos tecidos acrílico tingidos com fio. Posicionar em zonas de sombra - Boyalı akrilik iplik kumaşlarda renk değişiklikleri standart ve doğal kabul edilir. Gölge alanlara yerleştiriniz - Изменения цвета следует считать нормой, они являются естественными в случае акриловых тканей с окрашенными волокнами. Размещать в тени

\* Trattamento laminato su richiesta con quantità minima - Laminated finish available on request with a minimum quantity - Traitement laminé sur demande avec une quantité minimum - Laminierte Ausrüstung auf Anfrage mit einer Mindestmenge - Tratamiento laminado bajo pedido con una cantidad mínima - Tratamento laminado sob encomenda com quantidade mínima - Talep üzerine minimum miktarda lamine işlem - Ламинированная обработка по запросу с минимальным количеством

## CUSCINO PASSEPARTOUT

tessuto

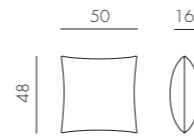

0,7 kg  
n. pz. 4

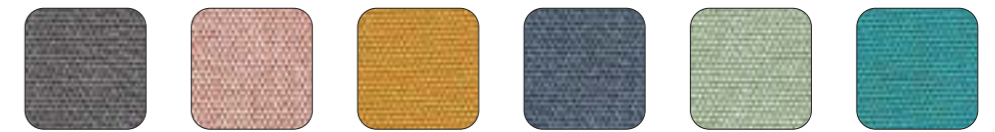

grey stone #  
36000.01.064

rosa quarzo #  
36000.01.066

senape #  
36000.01.069

denim #  
36000.01.070

the verde #  
36000.01.071

sardinia #  
36000.01.072

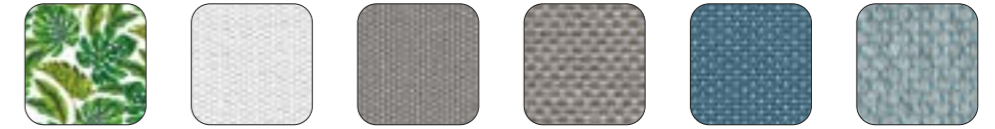

tropical  
36000.01.081

bianco  
36000.01.155

grigio #  
36000.01.163

grigio Sunbrella®  
36000.01.136

adriatic Sunbrella®  
36000.01.142

ghiaccio Sunbrella®  
36000.01.138

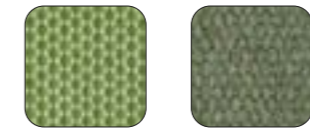

avocado Sunbrella®  
36000.01.139

giungla Sunbrella®  
36000.01.140

## CUSCINO RETTANGOLARE

tessuto

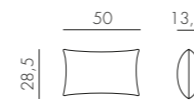

0,55 kg  
n. pz. 4

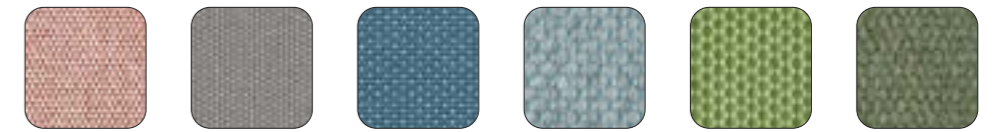

rosa quarzo #  
36000.02.066

grigio #  
36000.02.163

adriatic Sunbrella®  
36000.02.142

ghiaccio Sunbrella®  
36000.02.138

avocado Sunbrella®  
36000.02.139

giungla Sunbrella®  
36000.02.140

# Variazioni di colore sono da ritenersi standard e naturali nei tessuti acrilici tinto filo. Posizionare in zone d'ombra - Colour variations are to be considered standard and natural in yarn-dyed acrylic fabrics. Position in shaded areas - Les variations de couleur des tissus acryliques au fil teint sont standard et naturelles. Placer dans des zones ombragées - Farbveränderungen sind als Standard und in im Garn gefärbten Acrylgeweben als natürlich zu betrachten. In schattigen Bereichen aufstellen - Las variaciones de color son normales y naturales en las telas acrílicas teñidas en hilo. Colocar en zonas de sombra - As variações de cor são consideradas standard e naturais nos tecidos acrílico tingidos com fio. Posicionar em zonas de sombra - Boyalı akrilik iplik kumaşlarda renk değişiklikleri standart ve doğal kabul edilir. Gölge alanlara yerleştiriniz - Изменения цвета следует считать нормой, они являются естественными в случае акриловых тканей с окрашенными волокнами. Размещать в тени

COVER SMALL **new** (4/6 SEDUTE / DIVANO 1 ELEMENTO)

tessuto

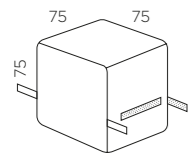

smoke  
37000.01.204

COVER MEDIUM **new** (2/4 LETTINI)

tessuto

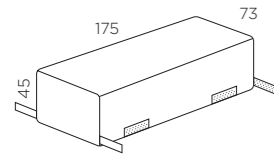

smoke  
37000.02.204

COVER LARGE **new** (DIVANO 2 ELEMENTI / TAVOLO 140)

tessuto

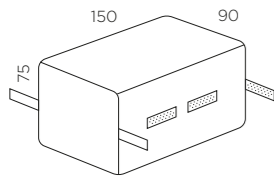

smoke  
37000.03.204

COVER EXTRALARGE **new** (DIVANO 3 ELEMENTI / TAVOLO 210)

tessuto

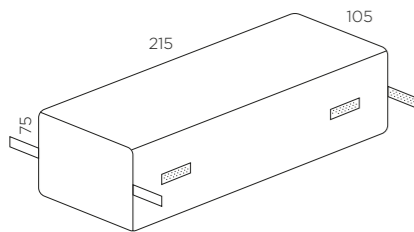

smoke  
37000.04.204

materiali  
*materials*

## polipropilene

Polipropilene trattato anti-UV e colorato in massa. Riciclabile al 100%.  
Polypropylene with UV additives and is uniformly colored. 100% Recyclable resin.  
Polypropylène traité anti-UV et coloré dans la masse. Résine recyclable 100%.  
UV-beständigem Polypropylen, voll durchgefärbt. 100% Recyclebarer Kunststoff.  
Polipropileno tratado anti-UV y teñido en masa. Resina reciclable 100%.  
Polipropileno com tratamento anti-UV colorido na totalidade. Resina reciclável 100%.  
Işığa dayanıklı ve boyalı olarak granül çekilmiş %100 geri dönüşümlü polipropilen kompozit hammadde.  
Полипропилен с обработкой анти-УФ, окрашенное в массе. На 100% пригодно для вторичной переработки.



BIANCO .00



GRIGIO .03



ANTRACITE .02



TORTORA .10



TABACCO .53



CAFFE' .05



OTTANIO .49



SALICE .04



MENTA .15



AGAVE .16



PERA .18



CAPPUCCINO .14



SENAPE .56



ROSA BOUQUET .08



MARSALA .21



CORALLO .75

## polipropilene fiberglass

Polipropilene fiberglass trattato anti-UV e colorato in massa. Resina riciclabile al 100%.  
Uniformly colored fiberglass polypropylene resins with UV additives. 100% Recyclable resin.  
Polypropylène fiberglass traité anti-UV et coloré dans la masse. Résine recyclable 100%.  
Uv-beständigem fiberglass Polypropylen, voll durchgefärbt. 100% Recyclebarer Kunststoff.  
Polipropileno fiberglass tratado anti-UV y teñido en masa. Resina reciclable 100%.  
Polipropileno fiberglass com tratamento anti-UV colorido na totalidade. Resina reciclável 100%.  
Işığa dayanıklı ve boyalı olarak granül çekilmiş %100 geri dönüşümlü cam elyaf katkılı polipropilen kompozit hammadde.  
Полипропилен фиброволокно с обработкой анти-УФ, окрашенное в массе. На 100% пригодно для вторичной переработки.

## polipropilene fiberglass rigenerato

Polipropilene fiberglass rigenerato trattato anti-UV e colorato in massa. Resina riciclabile al 100%. Il polipropilene fiberglass rigenerato può subire delle variazioni di colore dovute all'utilizzo di materiale riciclato.  
Regenerated uniformly colored fiberglass polypropylene resins with UV additives. 100% Recyclable resin. Regenerated fiberglass polypropylene may undergo variations in color due to the use of recycled material.  
Polypropylène fiberglass régénérée traité anti-UV et coloré dans la masse. Résine recyclable 100%. Polypropylène fiberglass régénérée peut subir variations de couleur en raison de l'utilisation de matériaux recyclés.  
Regeneriertem UV-beständigem fiberglass-Polypropylen, voll durchgefärbt. 100% Recyclebarer Kunststoff. Regeneriertem fiberglass-Polypropylen kann aufgrund der Verwendung von recyceltem Material Farbabweichungen unterliegen.

Polipropileno fiberglass regenerado tratado anti-UV y teñido en masa. Resina reciclable 100%. El polipropileno fiberglass regenerado puede sufrir variaciones de color debido al uso de material reciclado.  
Polipropileno fiberglass regenerado com tratamento anti-UV colorido na totalidade. Resina reciclável 100%. O polipropileno fiberglass regenerado pode sofrer variações de cor devido ao uso de material reciclado.  
Uv katlı maddeleriyle fiberglass polipropilen reçine ile renklendirilip düzgün bir şekilde tekrar oluşturulmuştur. Rejenere edilmiş polipropilen fiberglass, geri dönüşüm malzemesi kullanımı nedeniyle renk değişikliklerine maruz kalabilir.  
Переработанный, крашеный, полипропилен fiberglass обработанный против проникновения ультрафиолетовых лучей. На 100% пригодно для вторичной переработки. Цвет регенерированного полипропиленового стекловолокна может претерпеть изменения вследствие использования переработанного материала.



TERRA .44

## tessuto acrilico #



Fibra acrilica 100% tinto filo. Trattamento antimacchia, antimuffa. Solidità alla luce 5/8. Lavabile a 30°.  
 100% yarn dyed acrylic. Dirt repellent and anti-mould treatment. 5/8 light fastness. Washable at 30°.  
 100% fibre acrylique teintée en fils. Traitement anti-taches et anti-moisissure. Résistance à la lumière 5/8. Lavable à 30°.  
 100% garngefärbtes Polyacryl Gewebe. Gegen Flecken und Schimmel Ausrüstung. Lichtechtheit 5/8. Waschbar bei 30°.

100% hilo teñido acrílico. Protección antimanchas, antimoho. Solidez a la luz 5/8. Lavable a 30°.  
 100% fibra acrílica tingida com fio. Tratamento antimancha e antimoho. Resistência à luz 5/8. Lavável a 30°.  
 %100 akrilik elyaf boyalı iplik. Leke itici, küf önleyici ile muamele edilmiş. Işık haslığı 5/8. 30°de yıkanabilir.  
 Акриловое волокно 100% окрашенное в пряде. Пятноустойчивая и противогрибковая обработка. Светостойкость 5/8. Стирать при 30°.

# Variazioni di colore sono da ritenersi standard e naturali nei tessuti acrilici tinto filo. Posizionare in zone d'ombra - Colour variations are to be considered standard and natural in yarn-dyed acrylic fabrics. Position in shaded areas - Les variations de couleur des tissus acryliques au fil teint sont standard et naturelles. Placer dans des zones ombragées - Farbveränderungen sind als Standard und in im Garn gefärbten Acrylgeweben als natürlich zu betrachten. In schattigen Bereichen aufstellen - Las variaciones de color

son normales y naturales en las telas acrílicas teñidas en hilo. Colocar en zonas de sombra - As variações de cor são consideradas standard e naturais nos tecidos acrílico tingidos com fio. Posicionar em zonas de sombra - Boyalı akrilik iplik kumaşlarda renk değişiklikleri standart ve doğal kabul edilir. Gölge alanlara yerleştiriniz - Изменения цвета следует считать нормой, они являются естественными в случае акриловых тканей с окрашенными волокнами. Размещать в тени.

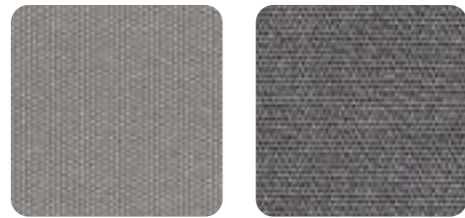

grigio .163  
240 gr/m<sup>2</sup>

grey stone .064  
240 gr/m<sup>2</sup>



artic .161  
240 gr/m<sup>2</sup>

sardinia .072  
240 gr/m<sup>2</sup>

denim .070  
240 gr/m<sup>2</sup>

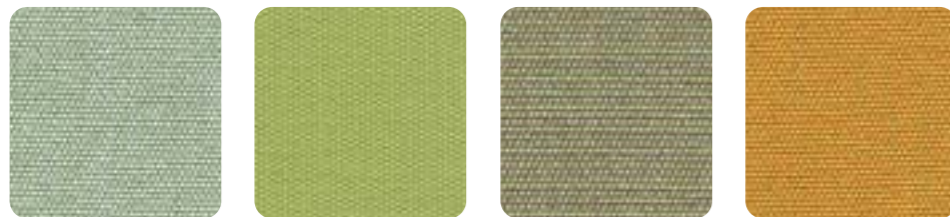

the verde .071  
240 gr/m<sup>2</sup>

lime .061  
240 gr/m<sup>2</sup>

felce .162  
240 gr/m<sup>2</sup>

senape .069  
240 gr/m<sup>2</sup>



rosa quarzo .066  
240 gr/m<sup>2</sup>

cherry .065  
240 gr/m<sup>2</sup>

## tessuto acrilico Sunbrella®



100% fibra acrilica Sunbrella® tinto in massa. Trattamento idrorepellente, antimacchia, antimuffa. Solidità alla luce 8/8. Lavabile a 40°.  
 100% Sunbrella® acrylic fiber mass dyed. Water repellent treatment, dirt repellent and anti-mould treatment. 8/8 light fastness. Washable at 40°.  
 100% fibre acrylique Sunbrella® teintée en masse. Traitement imperméable, anti-taches et anti-moisissure. Résistance à la lumière 8/8. Lavable à 40°.  
 100% fasergefärbtes Sunbrella® Polyacryl. Wasserabweisend Ausrüstung, gegen Flecken und Schimmel ausgerüstet. Lichtechtheit 8/8. Waschbar bei 40°.

100% fibra acrílica Sunbrella® tintada en masa. Tratamiento por la repelencia al agua, protección antimanchas, antimoho. Solidez a la luz 8/8. Lavable a 40°.  
 100% fibra acrílica Sunbrella® tingida em massa. Tratamento hidrorrepelente, antimancha e antimoho. Resistência à luz 8/8. Lavável a 40°.  
 %100 akrilik elyaf Sunbrella® çözelti halindeyken boyanmış. Su itici, leke itici, küf önleyici ile muamele edilmiş. Işık haslığı 8/8. 40°de yıkanabilir.  
 100% акриловое волокно Sunbrella®, окрашенное в массе. Водоотталкивающая, пятноустойчивая и противогрибковая обработка. Светостойкость 8/8. Стирать при 40°.

★ 50% fibra acrilica Sunbrella® riciclata tinto in massa, 47% fibra acrilica Sunbrella® tinto in massa, 3% poliéster.  
 50% blended Sunbrella® acrylic fiber mass dyed, 47% Sunbrella® acrylic fiber mass dyed, 3% polyester.  
 50% fibre acrylique Sunbrella® recyclée teintée en masse, 47% fibre acrylique Sunbrella® teintée en masse, 3% de polyester.  
 50% fasergefärbtes, recycletes Sunbrella® Polyacryl, 47% fasergefärbtes Sunbrella® Polyacryl, 3% Polyester.

50% fibra acrílica Sunbrella® reciclada tintada en masa, 47% fibra acrílica Sunbrella® tintada en masa, 3% poliéster.  
 50% fibra acrílica Sunbrella® reciclada tingida em massa, 47% fibra acrílica Sunbrella® tingida em massa, 3% de poliéster.  
 %50 geri dönüştürülmüş akrilik elyaf Sunbrella® çözelti halindeyken boyanmış, %47 akrilik elyaf Sunbrella® çözelti halindeyken boyanmış, %3 polyester.  
 50% переработанное акриловое волокно Sunbrella® окрашенное в массе, 47% акриловое волокно Sunbrella®, окрашенное в массе, 3% полиэстер.

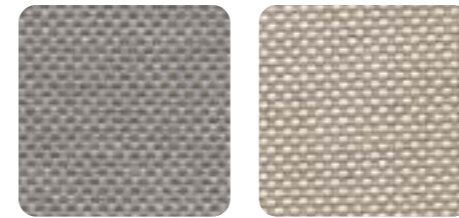

grigio Sunbrella® .136  
275 gr/m<sup>2</sup>

canvas Sunbrella® .141  
275 gr/m<sup>2</sup>

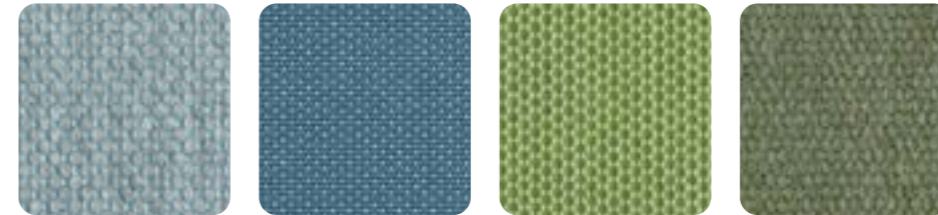

ghiaccio Sunbrella® .138  
275 gr/m<sup>2</sup>

adriatic Sunbrella® .142  
260 gr/m<sup>2</sup>

avocado Sunbrella® .139  
260 gr/m<sup>2</sup>

giungla Sunbrella® .140 ★  
340 gr/m<sup>2</sup>



## Sunbrella® EXTRA



Tessuti disponibili su ordinazione per minimi quantitativi d'ordine solo per il prodotto KOMODO.

Fabrics available to order for minimum order quantities for the KOMODO product only.

Tissus disponibles sur commande de quantités minimales pour le produit KOMODO uniquement.

Gewebe auf Bestellung für Mindestbestellmengen nur für das Produkt KOMODO erhältlich.

Telas disponibles bajo pedido para cantidades mínimas solo para el producto KOMODO.

Tecidos disponíveis por encomenda para quantidades mínimas de encomenda apenas para o produto KOMODO.

Sadece KOMODO ürünü için minimum sipariş miktarına göre sipariş verilebilecek kumaşlar.

ткани на заказ для минимального объема заказа только для изделия KOMODO.

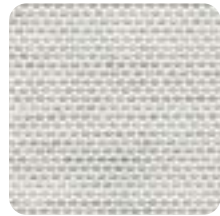

marble  
Sunbrella® .186  
260 gr/m<sup>2</sup>



blue storm  
Sunbrella® .185  
260 gr/m<sup>2</sup>

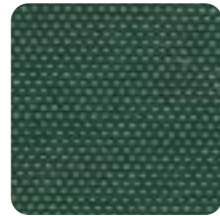

alpine  
Sunbrella® .182  
260 gr/m<sup>2</sup>

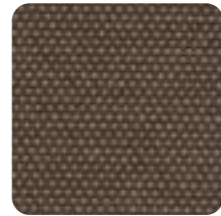

mink brown  
Sunbrella® .183  
260 gr/m<sup>2</sup>

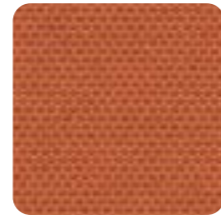

pumpkin  
Sunbrella® .184  
260 gr/m<sup>2</sup>



opera  
Sunbrella® .187  
260 gr/m<sup>2</sup>

## trattamento laminato

(Su richiesta - On request - Sur demande - Auf Anfrage - Bajo pedido - Sob encomenda - İstek üzerine - По запросу)



Il tessuto è accoppiato internamente con un film in poliuretano che lo rende impermeabile. La parte accoppiata in poliuretano non deve essere esposta al sole. Applicabile su richiesta con quantità minima su tessuti acrilici Sunbrella®.

The fabric is bonded with a polyurethane film that makes it waterproof. The polyurethane laminated surface should not be exposed to direct sunlight. Applicable on Sunbrella® acrylic fabrics on request with a minimum quantity.

Le tissu est doublé en interne avec un film de polyuréthane qui le rend imperméable. La partie en polyuréthane ne doit pas être exposée au soleil. Applicable sur demande avec une quantité minimale sur les tissus acryliques Sunbrella®.

Das Gewebe ist innen mit einer Polyurethanfolie verbunden, die es wasserdicht macht. Das mit Polyurethan verbundene Teil darf nicht der Sonne ausgesetzt werden. Auf Anfrage mit Mindestmenge auf Sunbrella® Polyacryl Gewebe anwendbar.

El tejido está acoplado internamente con una película de poliuretano que lo hace impermeable. La parte acoplada de poliuretano no debe exponerse al sol. Aplicable bajo pedido con una cantidad mínima en tejidos acrílicos Sunbrella®.

O tecido é dublado com filme interno de poliuretano que o torna impermeável. O lado que possui o filme de poliuretano não pode ser exposta ao sol. Aplicable sob encomenda, com quantidade mínima, em tecidos acrílicos Sunbrella®.

Kumaş, su geçirmez hale getiren bir poliüretan film ile dahili olarak birleştirilmiştir. Birleştirilmiş poliüretan bölümler güneşe maruz bırakılmamalıdır. Sunbrella® akrilik kumaşlar üzerine minimum miktarda istek üzerine uygulanabilir.

Ткань внутренне соединена с полиуретановой пленкой, которая делает ее водонепроницаемой. та часть ,где имеется добавка полиуритана не выставлять на солнце. Применяется по запросу с минимальным количеством на акриловых тканях Sunbrella®.

## tessuto acrilico tinto massa



100% fibra acrilica tinto in massa. Trattamento idrorepellente, antimacchia, antimuffa. Solidità alla luce 7/8. Lavabile a 30°.

100% acrylic fiber mass dyed. Water repellent treatment, dirt repellent and anti-mould treatment. 7/8 light fastness. Washable at 30°.

100% fibre acrylique teintée en masse. Traitement imperméable, anti-taches et anti-moisissure. Résistance à la lumière 7/8. Lavable à 30°.

100% fasergefärbtes Polyacryl. Wasserabweisend Ausrüstung, gegen Flecken und Schimmel ausgerüstet. Lichtechtheit 7/8. Waschbar bei 30°.

100% fibra acrilica tintada en masa. Tratamiento hidropelente, protección antimanchas, antimoho. Solidez a la luz 7/8. Lavable a 30°.

100% fibra acrilica tingida em massa. Tratamento hidropelente, antimancha e antimoho. Resistência à luz 7/8. Lavável a 30°.

%100 akrilik elyaf çözümlü halindeyken boyanmış. Su itici, leke itici, küf önleyici ile muamele edilmiş. Işık hızlığı 7/8. 30°de yıkanabilir.

100% акриловое волокно окрашенное в массе. Водоотталкивающая, пятноустойчивая и противоплесневая обработка. Светостойкость 7/8. Стирать при 30°.



lino .152  
280 gr/m<sup>2</sup>

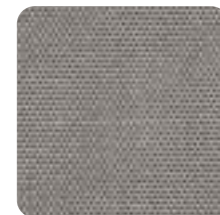

grigio Komodo .172  
240 gr/m<sup>2</sup>

## tessuto acrilico tinto massa per Komodo ombra



100% fibra acrilica tinto in massa. Trattamento idrorepellente, antimacchia, antimuffa. Solidità alla luce 7-8/8. Lavabile a 30°. Il tessuto Velo deve essere impiegato solo come telo-parasole. La maglia larga permette l'aerazione e allo stesso tempo crea una zona d'ombra sottostante ma non trattiene l'acqua.

100% acrylic fiber mass dyed. Water repellent treatment, dirt repellent and anti-mould treatment. 7-8/8 light fastness. Washable at 30°. Velo fabric should only be used for sunshades. Its wide mesh allows ventilation while creating a shaded area below, but it does not retain water.

100% fibre acrylique teintée en masse. Traitement imperméable, anti-taches et anti-moisissure. Résistance à la lumière 7-8/8. Lavable à 30°. Le tissu Velo ne doit être utilisé que comme toile de parasol. Les mailles larges permettant de s'aérer tout en créant, en même temps, une zone d'ombre en dessous. Velo n'est pas imperméable.

100% fasergefärbtes Polyacryl. Wasserabweisend Ausrüstung, gegen Flecken und Schimmel ausgerüstet. Lichtechtheit 7-8/8. Waschbar bei 30°. Das Gewebe Velo darf nur als Sonnenschutz Tuch verwendet werden. Die großen Maschen gestatten die Belüftung und gleichzeitig bildet sich darunter ein Schattenbereich, doch es hält Wasser nicht zurück.

100% fibra acrilica tintada en masa. Tratamiento hidropelente, protección antimanchas, anti-

moho. Solidez a la luz 7-8/8. Lavable a 30°. La tela Velo debe utilizarse únicamente como parasol, la malla ancha permite la ventilación y crea por debajo una zona de sombra, pero no protege del agua.

100% fibra acrilica tingida em massa. Tratamento hidropelente, antimancha e antimoho. Resistência à luz 7-8/8. Lavável a 30°. O tecido Velo deve ser utilizado apenas como pano guarda-sol, a malha larga permite o arejamento e ao mesmo tempo cria uma zona de sombra subjacente, mas não retém a água.

%100 akrilik elyaf çözümlü halindeyken boyanmış. Su itici, leke itici, küf önleyici ile muamele edilmiş. Işık hızlığı 7-8/8. 30°de yıkanabilir. Velo dokuma sadece güneşlik olarak kullanılmalıdır, geniş gözenekler havalandırma sağlar ve aynı zamanda aşağıda bir gölge alanı oluşturur, fakat su tutma özelliği yoktur.

100% акриловое волокно, окрашенное в массе. Водоотталкивающая, пятноустойчивая и противоплесневая обработка. Светостойкость 7-8/8. стирать при 30°. Ткань Velo предназначена исключительно для использования в качестве тента для защиты от солнца. Переплетение в виде крупной сетки обеспечивает вентиляцию и в то же время создает затенение под собой, но не задерживает влагу.

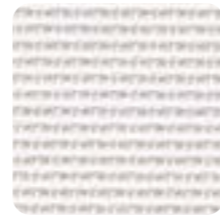

velo white .203  
150 gr/m<sup>2</sup>

## tessuto acrilico stampato



Fibra acrilica 100% stampa digitale. Solidità alla luce 6. Lavabile a 30°.

100% acrylic fiber with digital print. 6 light fastness. Washable at 30°.

100% fibre acrylique impression numérique. Résistance à la lumière 6. Lavable à 30°.

100% Polyacrylfaser mit Digitaldruck. Lichtechtheit 6. Waschbar bei 30°.

100% fibra acrilica impresión digital. Solidez a la luz 6. Lavable a 30°.

100% fibra acrilica estampa digital. Resistência à luz 6. Lavável a 30°.

%100 dijital baskı akrilik elyaf. Işık hızlığı 6. 30°de yıkanabilir.

100% акриловое волокно с цифровым рисунком, окрашенное в процессе производства. Светостойкость 6. Стирка при 30°.



tropical .081  
190 gr/m<sup>2</sup>

## TECH

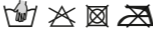

50% vinile e 50% poliestere. Trattamento idrorepellente, antimacchia, antimuffa, ignifugo e antibatterico. Solidità alla luce 6. Lavare a mano in acqua fredda. Alla base dei cuscini seduta komodo TECH panama viene applicata una rete a maglia larga in poliestere per permettere la traspirazione.

50% vinyl and 50% polyester. The treatment makes the coating: water repellent, and resistant to staining, resistant to mold, fire retardant, and antibacterial. 6 light fastness. Hand wash in cold water. At the bottom of the komodo seat cushions, made with TECH panama, the fabric is a polyester wide mesh to allow breathability.

50% vinyl e 50% poliestere. Traitement imperméable, anti-taches, anti-moisissures, ignifugé et antibactérien. Résistance à la lumière 6. Laver à la main à l'eau froide. À la base des coussins d'assise komodo TECH panama, un filet de polyester à larges mailles est appliqué pour évacuer la transpiration.

50% Vinyl und 50% Polyester. Wasserabweisend, gegen Flecken und Schimmelbildung ausgerüstet, feuerfest und antibakteriell. Lichteinheit 6. Handwäsche in kaltem Wasser. Auf der Unterseite der TECH panama Komodo-Sitzkissen ist ein atmungsaktives Polyesternetz mit großer Maschenweite angebracht, um Luftaustausch zu ermöglichen.



**TECH panama .131**

830 gr/m²

50% vinilo y 50% poliéster. Tratamiento para repeler el agua, ignifugo y antibacteriano, protección antimanchas, antimoho. Solidez a la luz 6. Lavar a mano en agua fría. En la base de los cojines de asiento del komodo TECH panama, se aplica una red de poliéster de malla ancha para permitir la transpiración.

50% de vinil e 50% de poliéster. Tratamento hidrorrepelente, antimancha e antimoho, resistente ao fogo e antibacteriano. Resistência à luz 6. Lavar à mão em água fria. Na base das almofadas do assento de komodo TECH panama, é aplicada uma tela de poliéster de malha larga para permitir a transpiração.

% 50 vinil ve % 50 polyester. Su Geçirmez Uygulama,kir tutmaz ve küf önleyici uygulama,yangın geciktirici ve antibakteriyel uygulama. Işık haslığı 6. Gerekliğinde, el ile soğuk suda yıkanabilir. Hava alması için komodo'nun altındaTECH panama minderle, geniş fileli polyester uygulanmıştır.

50% винил и 50% полиэстер. типы обработки: водоталкивающая,платноталкивающая,пленсеньоталкивающая,невозгораемая и антибактериальная устойчивость к . Светостойкость 6. Ручная стирка в холодной воде. в основе подушек komodo материал Tech panama добавлена сетка с широкой вязкой из полиэстера, чтобы материал проветривался.

## tessuto 100% Olefin



100% Olefin tinto in massa. Trattamento antimacchia, antimuffa. Solidità alla luce 7/8. Lavabile a 40°.

100% Olefin mass dyed. Dirt repellent and anti-mould treatment. 7/8 light fastness.

Washable at 40°.

100% Olefin teintée en masse. Traitement anti-taches et anti-moisissure. Résistance à la lumière 7/8. Lavable à 40°.

100% fasergefärbtes Olefin. Gegen Flecken und Schimmel Ausrüstung. Lichteinheit 7/8. Waschbar bei 40°.

100% Olefin tintada en masa. Protección antimanchas, antimoho. Solidez a la luz 7/8.

Lavable a 40°.

100% Olefin tingida em massa. Tratamento antimancha e antimoho. Resistência à luz 7/8. Lavável a 40°.

%100 Olefin çözelti halindeyken boyanmış. Leke itici, küf önleyici ile muamele edilmiş. Işık haslığı 7/8. 40°de yıkanabilir.

100% Olefin, окрашенный в массе. Пятноустойчивая и противоплесневая обработка.

Светостойкость 7/8. Стирать при 40°.



**bianco .155**

190 gr/m²



**caffè .165**

190 gr/m²

## cuscino Trill termoformato



Tessuto Sunbrella® Terry: 76% fibra acrilica Sunbrella® tinto in massa e 24% poliestere. Trattamento antimacchia, antimuffa. Solidità alla luce 7/8. Senza cuciture. Lavabile a 30°.

Imbottitura: poliuretano espanso rivestito da una membrana TPU waterproof. Densità 40 kg/m³. Sunbrella® Terry Fabric: 76% Sunbrella® acrylic fiber mass dyed and 24% polyester. Dirt repellent and anti-mould treatment. 7/8 light fastness. Seamless. Washable at 30°.

padding: polyurethane foam with a TPU waterproof membrane coating. Density 40 kg/m³. Sunbrella® Terry Tissu: 76% fibre acrylique Sunbrella® teintée en masse et 24% polyester. Traitement anti-taches et anti-moisissure. Résistance à la lumière 7/8. Sans couture. Lavable à 30°.

Rembourrage: mousse polyuréthane revêtu d'une membrane TPU imperméable. Densité 40 kg/m³.

Sunbrella® Terry Gewebe: 76% fasergefärbtes Polyacryl Sunbrella® und 24% Polyester. Gegen Flecken und Schimmel Ausrüstung. Lichteinheit 7/8. Ohne Nähte. Waschbar bei 30°.



**cenere .132**

550 gr/m²

## imbottitura

### CUSCINO FOLIO COMFORT

Poliuretano espanso (densità 18 kg/m³) rivestito da fibra di poliestere accoppiata al tessuto. Polyurethane foam (density 18 kg/m³) with a polyester fiber coating bonded to the fabric. Mousse polyuréthane (densité 18 kg/m³) revêtu de fibre de polyester couplé au tissu.Polyurethanschaum (Dichte 18 kg/m³) mit Polyesterfasern beschichtet, gekoppelt mit dem Gewebe. Espuma de poliuretano (densidad 18 kg/m³) cubierta con fibras de poliéster acoplada con el tejido. Espuma de poliuretano (densidade 18 kg/m³) com cobertura fibras de poliéster acoplada ao tecido. Kumaşa birleştirilmiş polyester elyafıa kaplanmış genişletilmiş poliüretan (yoğunluk 18 kg/m³). Расширенный полиуретан (плотность 18 кг/м³), покрытый полиэфирным волокном, соединенным с тканью.

### CUSCINO NET BENCH - CUSCINO NET RELAX - CUSCINO NET - CUSCINO FIT ARIA

Poliuretano espanso. Densità 28 kg/m³. Polyurethane foam. Density 28 kg/m³. Mousse polyuréthane. Densité 28 kg/m³. Polyurethanschaum. Dichte 28 kg/m³. Espuma de poliuretano. Densidad 28 kg/m³. Espuma de poliuretano. Densidade 28 kg/m³. Poliüretan köpük. Yoğunluk 28 kg/m³. Пенополиуретан. Плотность 28 кг/м³.

### CUSCINO SEDUTA ARIA

Poliuretano espanso. Densità 25 kg/m³. Polyurethane foam. Density 25 kg/m³. Mousse polyuréthane. Densité 25 kg/m³. Polyurethanschaum. Dichte 25 kg/m³. Espuma de poliuretano. Densidad 25 kg/m³. Espuma de poliuretano. Densidade 25 kg/m³. Poliüretan köpük. Yoğunluk 25 kg/m³. Пенополиуретан. Плотность 25 кг/м³.

### CUSCINO SHELL NET RELAX

Poliuretano espanso su struttura rigida di polipropilene. Densità 70 kg/m³. Polyurethane foam over solid polypropylene frame. Density 70 kg/m³. Mousse polyuréthane sur structure rigide de polypropylène. Densité 70 kg/m³. Polyurethanschaum auf steifer Polypropylengestell. Dichte 70 kg/m³. Espuma de poliuretano sobre estructura rígida de polipropileno. Densidad 70 kg/m³. Espuma de poliuretano sobre estrutura rígida de polipropileno. Densidade 70 kg/m³. Sert polipropilen gövde üzerinde poliüretan köpük minder. Yoğunluk 70 kg/m³. Пенополиуретан. на жесткой конструкции из полипропилена. Плотность 70 кг/м³.

### CUSCINO DOGA RELAX - CUSCINO DOGA ARMCHAIR - CUSCINO DOGA BISTROT

Poliuretano espanso (densità 18 kg/m³) rivestito da fibra di poliestere (densità 100 gr/m²). Polyurethane foam (density 18 kg/m³) with a polyester fiber coating (density 100 gr/m²). Mousse polyuréthane (densité 18 kg/m³) revêtu de fibre de polyester (densité 100 gr/m²). Polyurethanschaum (Dichte 18 kg/m³) mit Polyesterfasern beschichtet (Dichte 100 gr/m²). Espuma de poliuretano (densidad 18 kg/m³) cubierta con fibras de poliéster (densidad 100 gr/m²). Espuma de poliuretano (densidade 18 kg/m³) com cobertura fibras de poliéster

Tejido Sunbrella® Terry: 76% fibra acrilica Sunbrella® tintada en masa y 24% poliestere. Protección antimanchas, antimoho. Solidez a la luz 7/8. Sin costuras. Lavable a 30°. Relleno: espuma de poliuretano recubierto con una membrana de TPU impermeable. Densidad 40 kg/m³.

Tecido Sunbrella® Terry: 76% fibra acrílica Sunbrella® tingida em massa e 24% poliéster. Tratamento antimancha e antimoho. Resistência à luz 7/8. Sem costuras. Lavável a 30°. Enchimento: espuma de poliuretano com cobertura de membrana TPU impermeável. Densidade 40 kg/m³.

Sunbrella® Terry Kumaş: %76 akrilik elyaf Sunbrella® çözelti halindeyken boyanmış ve %24 polyester. Leke itici, küf önleyici ile muamele edilmiş. Işık haslığı 7/8.Dikişsiz. 30°de yıkanabilir. Dolgu malzemesi: TPU waterproof film ile kaplanmış poliüretan köpük. Yoğunluk 40 kg/m³.

Ткань Sunbrella® Terry: 76% акриловое волокно Sunbrella®, окрашенное в массе и 24% полиэстера. Пятноустойчивая и противоплесневая обработка. Светостойкость 7/8. Без швов. Стирать при 30°. Навивка: пенополиуретан с покрытием из водостойкой мембраны ТПУ. Плотность 40 кг/м³.

(densidade 100 gr/m²). Polyester elyaf (Yoğunluk 100 gr/m²) kaplı köpük poliüretan (Yoğunluk 18 kg/m³). Пенополиуретан (Плотность 18 кг/м³) с покрытием из обшивки из полиэстера (Плотность 100 гр/м²).

### CUSCINO BIT

Poliuretano espanso (densità 17,10 kg/m³) rivestito da fibra di poliestere (densità 200 gr/m²). Polyurethane foam (density 17,10 kg/m³) with a polyester fiber coating (density 200 gr/m²). Mousse polyuréthane (densité 17,10 kg/m³) revêtu de fibre de polyester (densité 200 gr/m²). Polyurethanschaum (Dichte 17,10 kg/m³) mit Polyesterfasern beschichtet (Dichte 200 gr/m²). Espuma de poliuretano (densidad 17,10 kg/m³) cubierta con fibras de poliéster (densidad 200 gr/m²). Espuma de poliuretano (densidade 17,10 kg/m³) com cobertura fibras de poliéster (densidade 200 gr/m²). Polyester elyaf (Yoğunluk 200 gr/m²) kaplı köpük poliüretan (Yoğunluk 17,10 kg/m³). Пенополиуретан (Плотность 17,10 кг/м³) с покрытием из обшивки из полиэстера (Плотность 200 гр/м²).

### CUSCINO PASSEPARTOUT - CUSCINO Rettangolo

Fibra di poliestere. Polyester fiber. Fibre de polyester. Polyesterfasern. Fibras de poliéster. Fibras de poliéster. Polyester elyaf. Обшивка из полиэстера.

### CUSCINO SEDUTA KOMODO - CUSCINO ARREDO ARIA

Poliuretano espanso (densità 25 kg/m³) rivestito da fibra di poliestere (densità 450 gr/m²). Polyurethane foam (density 25 kg/m³) with a polyester fiber coating (density 450 gr/m²). Mousse polyuréthane (densité 25 kg/m³) revêtu de fibre de polyester (densité 450 gr/m²). Polyurethanschaum (Dichte 25 kg/m³) mit Polyesterfasern beschichtet (Dichte 450 gr/m²). Espuma de poliuretano (densidad 25 kg/m³) cubierta con fibras de poliéster (densidad 450 gr/m²). Espuma de poliuretano (densidade 25 kg/m³) com cobertura fibras de poliéster (densidade 450 gr/m²). Polyester elyaf (Yoğunluk 450 gr/m²) kaplı köpük poliüretan (Yoğunluk 25 kg/m³). Пенополиуретан (Плотность 25 кг/м³) с покрытием из обшивки из полиэстера (Плотность 450 гр/м²).

### CUSCINO SCHIENALE KOMODO - CUSCINO SCHIENALE ANGOLO KOMODO

Poliuretano espanso (densità 21 kg/m³) rivestito da fibra di poliestere (densità 450 gr/m²). Polyurethane foam (density 21 kg/m³) with a polyester fiber coating (density 450 gr/m²). Mousse polyuréthane (densité 21 kg/m³) revêtu de fibre de polyester (densité 450 gr/m²). Polyurethanschaum (Dichte 21 kg/m³) mit Polyesterfasern beschichtet (Dichte 450 gr/m²). Espuma de poliuretano (densidad 21 kg/m³) cubierta con fibras de poliéster (densidad 450 gr/m²). Espuma de poliuretano (densidade 21 kg/m³) com cobertura fibras de poliéster (densidade 450 gr/m²). Polyester elyaf (Yoğunluk 450 gr/m²) kaplı köpük poliüretan (Yoğunluk 21 kg/m³). Пенополиуретан (Плотность 21 кг/м³) с покрытием из обшивки из полиэстера (Плотность 450 гр/м²).

## tessuto sintetico

Tessuto in filo di poliestere rivestito in pvc.  
Fabric is made of a polyester fiber, with a pvc coating.  
Tissu en fil de polyester revêtu de pvc.  
Gewebe aus PVC-ummantelten Polyesterfasern.

Tejido en hilo de poliéster recubierto de pvc.  
Tecido de fibra polyester com cobertura pvc.  
PVC kaplı polyester elyaf tekstil.  
Ткань из полиэфирных нитей с покрытием из ПВХ.



bianco .107  
tela 1x1

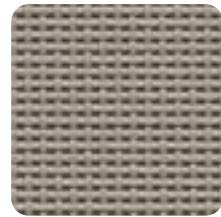

tortora .104  
tela 1x1

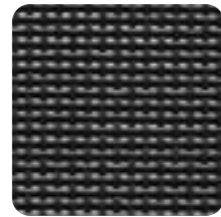

antracite .057  
tela 1x1

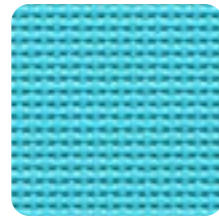

celeste .075  
tela 1x1

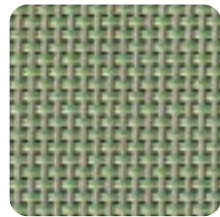

agave .101  
tela 2x1

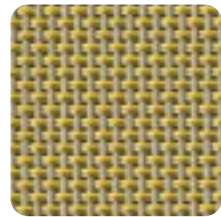

deserto .103  
tela 2x1

## tessuto Cover



56% poliestere e 44% poliuretano. Trattamento idrorepellente, antimacchia, antimuffa e antibatterico. Solidità alla luce 7/8. Lavabile a 95° con detergente neutro.

56% polyester and 44% polyurethane. The treatment makes the coating: water repellent, and resistant to staining, resistant to mold and antibacterial. 7/8 light fastness. Washable at 95° with neutral detergent.

56% polyester et 44% polyuréthane. Traitement imperméable, anti-taches, anti-moisissures et antibactérien. Résistance à la lumière 7/8. Lavable à 95° avec un détergent neutre.

56% Polyester und 44% Polyurethan. Wasserabweisend, gegen Flecken und Schimmelbildung ausgerüstet und antibakteriell. Lichtechtheit 7/8. Waschbar bei 95° mit Neutralwaschmittel.

56% poliéster y 44% poliuretano. Tratamiento para repeler el agua, antimanchas, antimoho y antibacteriano. Solidez a la luz 7/8. Lavable a 95° con detergente neutro.

56% de poliéster e 44% poliuretano. Tratamento hidropelente, antimancha, antimoho e antibacteriano. Resistência à luz 7/8. Lavável a 95° com detergente neutro.

% 56 polyester ve % 44 poliüretan. Su Geçirmez Uygulama, kir tutmaz ve küf önleyici uygulama, antibakteriyel uygulama. Işık haslığı 7/8. Naturel deterjanla 95°de yıkanabilir.

56% полиэстер и 44% полиуретан. типы обработки: водоталкивающая,пятноталкиваю щая,плесеньоталкивающая, и антибактериальная устойчиво к. Светостойкость 7/8. Можно стирать при 95 ° с нейтральным мощным средством.



smoke .204  
205 gr/m<sup>2</sup>

## alluminio verniciato

La verniciatura è a polvere di poliestere.  
The painting is with polyester powder.  
La peinture est à poudre de polyester.  
Die Epoxierung erfolgt mit Polyesterpulver.

El pintado se realiza con polvo de poliéster.  
O pó de poliéster é usado para envernizar.  
Boyası polyester tozla yapılır.  
Окраска производится при помощи порошкового полиэстера.



verniciato bianco .53



verniciato tortora .59



verniciato caffè .57



verniciato antracite .52

## laminato HPL (10 mm)

Laminato decorativo ad alta pressione, compatto, omogeneo, non poroso, ad alta densità. Spessore 10 mm.  
Decorative high pressure laminate, solid, homogeneous, non-porous and with a high density. Thickness 10 mm.  
Stratifié décoratif à haute pression, condensé, homogène, pas poreux, haute densité. Epaisseur 10 mm.  
HPL-Laminat, beständig, homogen, hoch verdichtet. Dicke 10 mm.

Laminado decorado a alta presión, compacto, homogéneo, no poroso y de alta densidad. Espesor 10 mm.  
Decorativo e laminado a alta pressão, sólido, homogéneo, não poroso e de grande densidade. Espessura 10 mm.  
Dekoratif yüksek basınçlı laminat, masif, gözeneksiz ve yüksek yoğunluklu. Kalınlık 10 mm.  
Декоративный ламинат высокого давления, компактный, однородный, непористый, с высокой плотностью. Толщина 10 мм.



BIANCO .301



ANTRACITE .303

## vetro

Vetro float temperato serigrafato e vetrificato a 700°C. Spessore 10 mm.  
Tempered float glass, screen-printed and vitrified at 700° C. Thickness 10 mm.  
Verre float trempé sérigraphié et vitrifié à 700°C. Epaisseur 10 mm.  
Sicherheitsglas mit innenliegendem Dekorsiebdruck, verglast bei 700°. Dicke 10 mm.  
Vidrio float, templado, serigrafado y vetrificado a 700°C. Espesor 10 mm.  
Vidro float temperado, impresso e vitrificado a 700°C. Espessura 10 mm.  
Temperli, üstü baskılı ve 700° C vitriyiye edilmiş. Kalınlık 10 mm.  
Сериграфированное закаленное стекло float, производимое при 700°C. Толщина 10 мм.



BIANCO .00



ANTRACITE .02

## vetro

Vetro extrachiaro temperato. Spessore 6 mm.  
Extra-clear tempered glass. Thickness 6 mm.  
Verre trempé extra clair. Epaisseur 6 mm.  
Extra klares gehärtetes Glas. Dicke 6 mm.  
Vidrio templado extra claro. Espesor 6 mm.  
Vidro temperado extra claro. Espessura 6 mm.  
Ekstra net temperli cam. Kalınlık 6 mm.  
Особо прозрачное закаленное стекло. Толщина 6 мм.

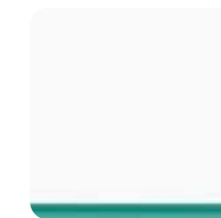

vetro .501

## durelTOP





DurelTOP è un sistema innovativo di produzione di piani per tavoli studiati per raggiungere i più elevati livelli di praticità, resistenza, robustezza ed eleganza. I piani DurelTOP sono ad alto spessore, formati da un doppio strato tamburato perfettamente chiuso. Prodotti in polipropilene di prima qualità, sono inalterabili all’acqua, resistenti al sole e facili da pulire. DurelTOP è il risultato di una lunga ricerca tecnologica e dell’esperienza decennale nella lavorazione delle materie plastiche della NARDI, da sempre all’avanguardia nell’ambiente contract e giardino.

The DurelTOP is an innovative new system in the production of tabletops developed to reach the highest levels of practicality, resistance, and elegance. The DurelTOP tabletops have a greater thickness, formed by a double layer enclosure perfectly closed. Produced in first quality polypropylene, they are resistant to water, resistant to sunlight, and are easy to clean. DurelTOP is a result of a decade’s long research and development in plastics by NARDI, always a leader in the contract and garden sectors.

DurelTOP est un système innovateur de production de plateaux de tables, il est étudié pour retrouver le meilleur niveau de pratique de résistance et d’élégance. Les plateaux DurelTOP sont très épais, formés de doubles couches parfaitement finies. Ce sont des produits en polypropylène de première qualité, ils sont inaltérables à l’eau, résistant au soleil et faciles à nettoyer. DurelTOP est le résultat d’une longue recherche technologique et une expérience décennale dans le travail des matières plastique de la Sté NARDI, toujours a l’avantgarde dans le secteur du contract et jardin.

DurelTOP ist ein neu entwickeltes System für die Produktion von Tischplatten, um ein Höchstmaß an Funktionalität, Widerstandsfähigkeit und Eleganz zu erreichen. Durch das innen verstärkte “Zwei-Schichten-Hohlraum-System” erreicht die DurelTOP Tischplatte einen stärkeren Querschnitt und damit ein Höchstmaß an Festigkeit. Hergestellt aus hochwertigem Qualitätspolypropylen ist sie resistent gegen Wasser und Sonnenlicht und dabei leicht zu reinigen. DurelTOP ist das Ergebnis von 10 Jahren Forschung und Entwicklung auf dem Kunststoffsektor durch NARDI, immer der führende im Bereich Contract und Gartenmöbel.



|  |  |
|--|--|
|   | impilabile stackable empilable stapelbar apilable empilhável istiflenebilir стекируемые                        |
|  | reclinabile reclining dossier réglable verstellbare Rückenlehne reclinable reclinável sırt pozisyonlu откидной |

Tutte le sedute sono dotate di piedini antiscivolo. All chairs are equipped with non-slip feet. Tous les sièges sont équipés avec patins anti-dérapants. Alle Stühle sind mit rutschfesten Fußkappen ausgestattet. Todos los asientos están equipados con tapones antideslizantes. Todos os assentos estão equipados com pés antiderrapantes. Bütün sandalyeler kaymaz ayaklıdırlar. Ножки всех стульев оснащены противоскользящей резиновой подложкой.



Sui colori scuri, ombre, striature ed altri difetti minori sono più evidenti rispetto ai colori chiari e sono da ritenersi standard. On dark colors, shadows, streaks and other minor faults are more evident than on lighter colors and are therfore standard. Sur les couleurs sombres, les ombres, les stries et les autres petits défauts sont plus marqués que sur les couleurs claires et sont tout à fait standards. Auf dunklen Farben sind Schatten, Streifen und andere kleinere Mängel sichtbarer als auf hellen Farben und sind daher als Standard zu betrachten. Las sombras, rayas y demás defectos menores son más evidentes sobre los colores oscuros respecto a los colores claros y tienen que considerarse como estándares. Em cores escuras, sombras, listras e outros defeitos menores são mais evidentes do que em cores claras e devem ser considerados standard. Koyu renkler üzerinde, gölgeler, çizgiler ve diğer küçük defolar açık renkler üzerinde olduklarından daha belirginleşmekte ve bu nedenle normal olarak değerlendirilmelidirler. По сравнению со светлыми цветами на темных цветах тени полоска и другие небольшие дефекты более заметны и должны считаться нормой.

DurelTOP table with a double layer enclosure perfectly closed.

Il peso (kg), le misure (cm) e i colori riportati sono indicativi. La NARDI si riserva il diritto di apportare modifiche o varianti senza preavviso. Tutti i modelli sono depositati. Weights (kg), dimensions (cm) and colors are indicative only. NARDI reserves the right to make changes or variations without notice. All models are patented. Le poids (kg), les dimensions (cm) et les coloris indiqués sont fournis purement à titre indicatif. La Firme NARDI se réserve le droit d’apporter toute modification ou variation sans aucun préavis. Tous les modèles sont déposés. Alle Farb-, Maß- (cm) und Gewichtsangaben (kg) sind nicht als fest bindet anzusehen Firma NARDI behält sich das Recht von Änderungen Alle Modelle sind gesetzlich geschützt. El peso (kg), las medidas (cm) y los colores detallados, son indicativos. La firma NARDI se reserva el derecho de modificaciones o variaciones sin previo aviso. Todos los modelos llevan nuestra marca. O peso (kg), as medidas (cm) e as cores indicadas, são indicativos. A NARDI reservase o direito de aportar modificações ou variações sem préaviso. Todos os modelos estão depositados. Ağırlık (Kg), boyutlar (cm) ve renkler gösterme amaçlıdır. NARDI'nin önceden bildirmeden değişiklik yapma hakkı vardır. Bütün modeller patentlidir. Приведенный вес (кг), размеры (см) и цвета являются ориентировочными. Компания NARDI оставляет за собой права вносить изменения и вариации без предварительного предупреждения. Все модели зарегистрированы.

DurelTOP es un nuevo sistema de fabricación de tableros de mesa estudiado para alcanzar los mas alstos niveles de practicidad, resistencia, robustez y elegancia. Los tableros DurelTOP de gran solidez, estan formados por una doble capa perfectamente unida y sellada. Fabricados en polipropileno de primera calidad son inalterables al agua, resistentes al sol y de fácil limpieza. DurelTOP es el resultado de una prolongada investigación tecnológica y de la experiencia acumulada en los mas de diez años que NARDI lleva produciendo materias plasticas, siempre innovando en ambientes contract y jardin.

DurelTOP é um sistema de inovação da produção de tampos de mesa concebidos para atingir a máxima resistência,práticos e elegantes. Os tampos de mesa DurelTOP são formados poruma camada dupla e perfeitamente unida. Produzidos em polipropileno de primeira qualidade, são resistentes ao sol e fáceis de limpar. DurelTOP é o resultado de uma longa investigação tecnológica em materiais plásticos da NARDI, leader em mobiliário de jardim.

DurelTOP, masa tablalarının üretiminde kullanılan yeni bir sistem olup, yüksek seviyede pratiklik, direnç ve de şıklık sunmak amacıyla geliştirilmiştir. DurelTOP masa tablaları fevkalade bir inceliğe sahip olup, kusursuz kapanan çift tabaka çevirme sistemiyle oluşturulmuştur. Nitelikli çamsakızından üretilmiş olup, suya ve güneş ışığına karşı dirençli ve temizlenmesi kolaydır. DurelTOP sistemini Contract ve de Bahçe sektöründe her zaman lider olan NARDI'nin uzun araştırmalarının sonucundan doğan, plastikte gelişim olarak adlandırabiliriz.

DurelTOP — это инновационная система производства столешниц, позволяющая изготавливать практичные, прочные, крепкие и элегантные столешницы. Столешницы DurelTOP обладают высокой плотностью и состоят из двойной панели с мелкопустотным заполнением, полностью закрытой. Изделия из полипропилен высокого качества устойчивы к воде, солнцу и просты в уходе. DurelTOP — это результат многолетних технологических исследований и десятилетнего опыта NARDI в обработке пластмасс, лидера в производстве садовой мебели и контрактном секторе.

**NARDI s.p.a.**  
Chiampo (VI) Italy  
tel. +39 0444 422100  
info@nardioutdoor.com  
www.nardioutdoor.com



10101127